

nobilia[®]

Badneuheiten Bathroom innovations

20



Inspiration
& Trends



Badneuheiten

Bathroom innovations

Ein Bad ist immer ein besonderer Raum. Er ist Rückzugsort, Wohlfühloase und etwas sehr Persönliches. Damit dieser Ort auch für Sie zu einem ganz eigenen wird, bieten wir Ihnen hochwertig verarbeitete Badmöbel, die von der Natur oder von aktuellen Trends des Interior Designs inspiriert sind. Sei es warme Holz-Optik, hochwertiger Schiefer, moderner Beton oder hochglänzende und matte Oberflächen: Für alle Ansprüche bieten wir ästhetische Designs mit individuellen Kombinationsmöglichkeiten. Damit Sie Ihre Zeit im Bad auch wirklich genießen können.

A bathroom is always a special room. It is a place of retreat, an oasis of well-being and a very personal space. To help you make it your very own, we supply high-quality bathroom furniture that has been inspired by nature or current trends in interior design.

Whether it's a warm wood look, high-quality slate, modern concrete or high gloss and matt surfaces: we offer aesthetically pleasing designs that can be individually combined to suit any requirements. So you can really enjoy the time you spend in your bathroom.

- 4** **Inspiration** Inspiration
- 12** **Trends** Trends
- 50** **Planungsvorschläge** Planning suggestions
- 67** **Dekore und Griffe** Décors and handles



Inspiration

Inspiration

Wir bieten ästhetische Designs und individuelle Kombinationsmöglichkeiten, mit denen jedes Bad zu einem ganz besonderen Ort wird.

—
We offer aesthetically pleasing designs that can be individually combined to turn every bathroom into a special place.





6-7



Inspiration Inspiration



LUX

817 Lack, Alpinweiß Hochglanz

817 Lacquer, alpine white high gloss



HOCHGLANZ HIGH GLOSS

Mit glänzenden Oberflächen erreichen Sie einen sehr hochwertigen Look in Ihrem Bad und sorgen gleichzeitig für eine optische Vergrößerung des Raums.

—
By using shiny surfaces, you can achieve a very high quality look in your bathroom and at the same time make it look larger.

FLASH

—
455 Lacklaminat, Seidengrau Hochglanz

455 Lacquered laminate, satin grey high gloss



8-9



Inspiration Inspiration

FLASH

503 Lacklaminat, Alpinweiß Hochglanz

503 Lacquered laminate, alpine white high gloss



CASCADA

772 Lacklaminat, Steingrau

772 Lacquered laminate, stone grey

STIMMUNGEN MOODS

Während Sie mit Hochglanz eine sehr moderne Stimmung erzeugen, sorgt der Landhausstil für mehr Gemütlichkeit im Bad. Schöne Details wie Kufen, besondere Griffe oder die Variation der Form machen hier zusätzlich den Unterschied.

While high gloss elements create a very modern atmosphere, the country house style provides more cosiness in the bathroom. Beautiful details such as runners, special handles or variations in shape are also what make the difference here.



MATT MATT

Frei schwebend oder mit Sockelfüßen als Gestaltungsmerkmal, mit farblich abgesetzten Arbeitsplatten, durchgehenden Griffleisten oder der pflegeleichten Antifingerprint-Beschichtung: Gerade bei matten Fronten machen die Details einen Raum zu Ihrem ganz eigenen Bad.

Free floating elements or with pedestal feet as a design feature, with contrasting colour counters, continuous handles or the easy care anti-fingerprint coating: with matt fronts in particular, it's the detail that turns a room into your very own bathroom.



TOUCH

340 Lacklaminat, Schwarz supermatt
340 Lacquered laminate, black supermatt





EASYTOUCH

963 Lacklaminat, Rostrot ultramatt

963 Lacquered laminate, rust red ultra matt



14
 Warm und
 natürlich
 warm grove



24
 Klare
 Stärke
 floating
 rock



Trends Trends

Unser Sortiment hochwertig verarbeiteter Badmöbel bietet Ihnen völlige Kombinations- und Gestaltungsfreiheit. Ihr Bad können Sie aus fünf aktuellen Lifestyle-Trends auswählen oder diese auch untereinander kombinieren. Immerhin geht es um nicht weniger als Ihr persönliches Wunschbad.

Our range of high quality bathroom furniture offers complete freedom in terms of design and different combinations. You can choose your bathroom from five current lifestyle trends or even combine them. After all, this is about nothing less than your personal dream bathroom.



34
**Soft
Touch**
soft
touch



28
**Urban und
industriell**
deep
industrial



44
**Licht
und Glanz**
reflecting
light



14-15



Warm und natürlich

**Nicht nur die Optik, auch die
Struktur von Holz bringt Leben
und Atmosphäre in jedes Bad.**

—
It is not just the look but also the
structure of wood that brings life
and atmosphere to every bathroom.

warm
grove



16-17

Warm und natürlich warm grove

STRUCTURA

405 Eiche Sierra Nachbildung

405 Sierra oak reproduction





STRUKTURGEBEND A SENSE OF STRUCTURE

**Mal harmonisch, mal als angenehmer Kontrast:
Die naturbelassene Optik der Eiche Sierra bringt
Struktur in viele Raum-Architekturen und sorgt
für einen frischen, warmen Look.**

Sometimes coordinated, sometimes contrasting.
The natural look of the Sierra oak lends a sense
of structure to the architecture of many rooms
and ensures a fresh, warm look.

18-19

Warm und natürlich warm grove

STRUCTURA

403 Eiche Nero Nachbildung

403 Nero oak reproduction





SOUVERÄN SOPHISTICATED

Das Schwarz der Eiche Nero strahlt eine selbstbewusste Eleganz aus und sorgt in jedem Bad für einen modern-minimalistischen Look.

The black of the Nero oak radiates self-confident elegance and gives every bathroom a modern minimalistic look.

20-21



Warm und natürlich warm grove

WOHNLICH-WARM COSY AND WARM

Diese dunklere und naturbelassen gemaserte Optik der Eiche Havanna setzt angenehm warme Kontraste in ansonsten kühl gehaltenen Bädern.

—
The dark and untreated grained look of the Havana oak provides beautiful warm contrasts in an otherwise cool-looking bathroom.



STRUCTURA

402 Eiche Havanna Nachbildung

402 Havana oak reproduction



22-23

Warm und natürlich warm grove



INLINE

551 Lack, Alpinweiß matt
551 Lacquer, honed alpine white

RIVA

887 Eiche Somerset Nachbildung
887 Somerset oak reproduction



IN KOMBINATION IN COMBINATION

Holz-Optiken und unifarbene Fronten sorgen zusammen immer für einen sehr eigenständigen Look. Die Kombination aus unserer hellen Eiche Somerset und mattweißen Fronten sorgt zum Beispiel für eine besondere Leichtigkeit. Farbige Fronten mit Eiche Havanna kreieren hingegen eine frische und moderne Optik.

Wood looks and solid coloured fronts always create a unique impression when used together. The combination of our light Somerset oak and the matt white fronts, for example, create an air of special lightness. Coloured fronts with Havana oak, by contrast, give rise to a fresh and modern look.

TOUCH

337 Lacklaminat, Aqua supermatt

337 Lacquered laminate, aqua supermatt



24-25



Klare Stärke floating rock

**Klare Linie, edle Optik: Schiefer
und Marmor schaffen besonders
elegante Umgebungen.**

—
Clear lines with a sophisticated
look: slate and marble give rise to
particularly elegant surroundings.







STONEART

304 Schiefer steingrau Nachbildung

304 Stone grey slate reproduction

STEIN STONE

Steingraue Schiefer-Elemente setzen in jedem Bad kultivierte Highlights. Auch Marmor-Elemente lassen sich zusammen mit einer supermatten Waschtischlösung zu einem modernen Schwarz-Weiß-Look kombinieren.

Stone grey slate elements act as sophisticated highlights in any bathroom. Marble elements can also be combined with a super matt hand basin to create a modern black and white look.





TOUCH

340 Lacklaminat, Schwarz supermatt

340 Lacquered laminate, black supermatt

CC 273 Carrara Nachbildung

CC 273 Carrara marble reproduction



Urban und industriell deep industrial



Urban und modern: Beton- und Zement-Optik setzen sich elegant von der grauen Masse ab.

—
Urban and modern: the concrete and cement look stand out from the grey mass market in an elegant way.



ZEMENT CEMENT

Die modern-puristische Optik von Zement kommt vor allem in minimalistisch gehaltenen Badezimmern zur Geltung.

—
The modern and purist look of cement comes into its own in minimalist style bathrooms in particular.





CEMENTO

803 Lack, Zementgrau

803 Lacquer, cement grey

32-33



RIVA

892 Beton grau Nachbildung

892 Concrete grey reproduction



Urban und industriell deep industrial

BETON CONCRETE

Der große Trend Beton-Look hat sich in den letzten Jahren weltweit etabliert. Zu Recht, denn die kühle Eleganz passt hervorragend in jedes moderne Badezimmer.

—
The big concrete look trend has established itself globally over the past few years. And rightly so, because its cool elegance perfectly suits a modern bathroom.





Soft Touch

soft
touch

Zeitlos hochwertig: Nicht nur in kleinen Räumen entfalten matte Oberflächen ihre ruhige Wirkung.

—

Timelessly high quality: matt surfaces have a calming effect, and not just in small spaces.



36-37



TOUCH

—
340 Lacklaminat, Schwarz supermatt
340 Lacquered laminate, black supermatt

Soft Touch soft touch





MATT KOMBINIERT

MATT COMBINED

Matte Fronten setzen in Kombination mit anderen Oberflächen – wie zum Beispiel Eiche oder Schiefer – angenehme Kontraste und schaffen Struktur.

—
Matt fronts provide pleasant contrasts and create structure when combined with other surfaces such as oak or slate.



38-39



KLARE LINIE CLEAR LINE

Sowohl auf hellen als auch auf dunklen Hintergründen setzen dezent farbige und supermatte Oberflächen elegante Highlights.

—
Subtly coloured and super matt surfaces provide elegant highlights on both light and dark backgrounds.

Soft Touch soft touch





TOUCH

334 Lacklaminat, Schiefergrau supermatt

334 Lacquered laminate, slate grey supermatt

40-41



LANDHAUSSTIL COUNTRY HOUSE STYLE

Mit facettierten, matten Fronten schaffen Sie einen gemütlichen bis lässigen Scandi-Look in Ihrem Bad.

—
With beautifully crafted matt fronts, you can create a cosy to casual minimalistic look in your bathroom.

Soft Touch soft touch



CASCADA

774 Lacklaminat, weiß

774 Lacquered laminate, white



HELL-DUNKEL LIGHT-DARK

Besonders der Kontrast zwischen hellen Fronten und dunkleren Wangen schafft einen modernen und spannungsreichen Look.

—
The contrast between light fronts and a dark body creates a modern and exciting look.





FASHION

165 Lack, Steingrau matt

165 Lacquer, honed stone grey



Licht und Glanz

reflecting light



Mehr Licht, mehr Raum: Hochglänzende Oberflächen erzeugen optische Tiefe und vergrößern damit das Bad.

—
More light, more space: high gloss surfaces create visual depth and make the bathroom appear larger.

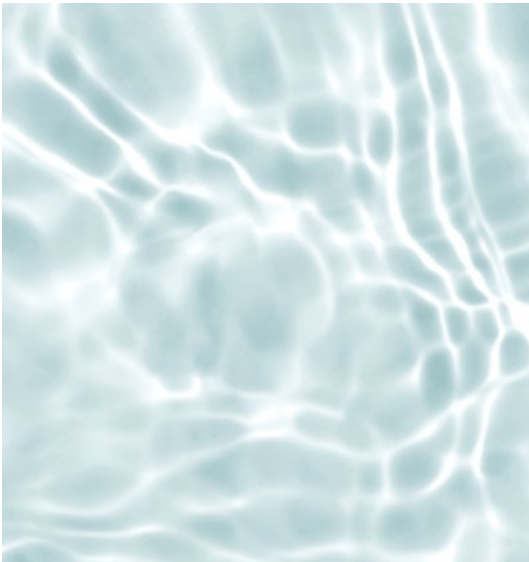



46-47

Licht und Glanz reflecting light



LUX

817 Lack, Alpinweiß Hochglanz

817 Lacquer, alpine white high gloss



FLASH

503 Lacklaminat, Alpinweiß Hochglanz

503 Lacquered laminate, alpine white high gloss

BLICKFANG EYE-CATCHER

Hochglänzende Badmöbel setzen im wahrsten Sinne des Wortes Highlights. In Weiß und angenehm ausgeleuchtet, sorgen sie zudem für eine sehr offene Raumarchitektur.

High gloss bathroom furniture is a highlight in the true sense of the word. In white and pleasantly illuminated, it also creates a very open architecture within the room.



OPTISCHE TIEFE

VISUAL DEPTH

Hochglänzende Fronten sorgen immer für eine optische Vergrößerung des Raums. Sie eignen sich damit ideal für kleinere Bäder, kommen aber auch in größeren Räumen voll zur Geltung.

—
High gloss fronts always make the space look bigger. They are therefore ideal for smaller bathrooms but they also come into their own in larger spaces.



FLASH

—
453 Lacklaminat, Schiefergrau Hochglanz
453 Lacquered laminate, slate grey high gloss



LUX

819 Lack, Seidengrau Hochglanz

819 Lacquer, satin grey high gloss



PLANUNGSVORSCHLÄGE

PLANNING SUGGESTIONS

Unsere Badmöbel können Sie immer individuell und passend für Ihre Bedürfnisse kombinieren. Ihr Fachhändler vor Ort unterstützt Sie gerne bei der Planung.

You can always combine our bathroom furniture individually to suit your needs. Your local dealer would be happy to help you with your plans.

mit Griff with handle

Waschtischgröße Hand basin size

600 mm

BSET60-001

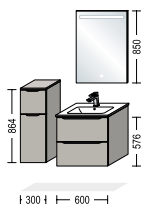

800 mm

BSET80-001

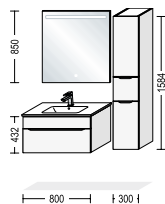

1000 mm

BSET100-001

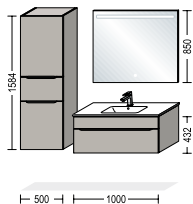

1200 mm

BSET120-001

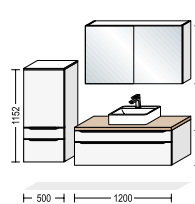

1500 mm

BSET150-001

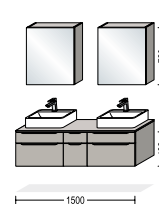

BSET60-002



BSET80-002

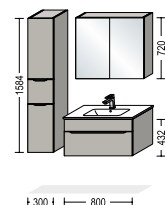

BSET100-002

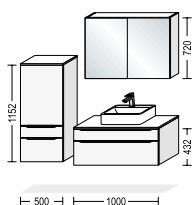

BSET120-002

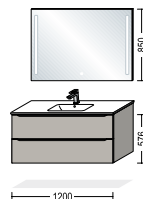

BSET150-002



BSET60-003

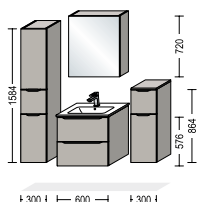

BSET80-003

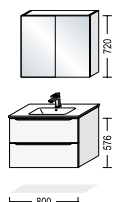

BSET100-003

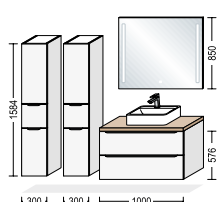

BSET120-003

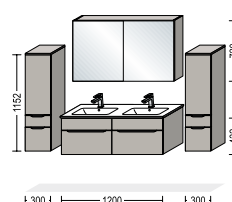

BSET80-004

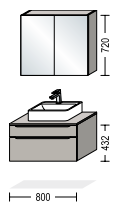

BSET120-004

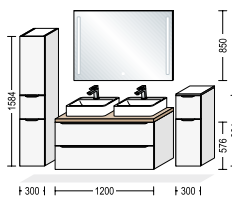

BSET80-005

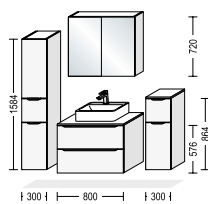

grifflos handleless

Waschtischgröße Hand basin size

600 mm

NBSET60-001

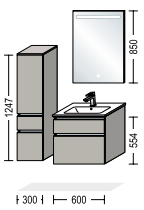

800 mm

NBSET80-001

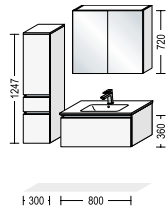

1000 mm

NBSET100-001

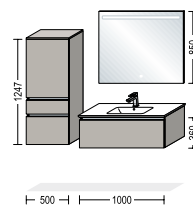

1200 mm

NBSET120-001

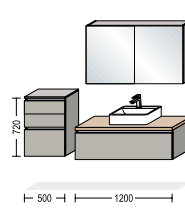

1500 mm

NBSET150-001

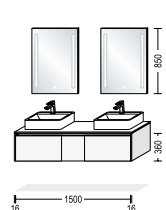

NBSET60-002

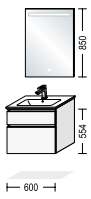

NBSET80-002

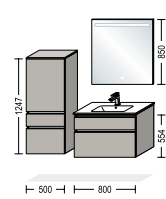

NBSET100-002

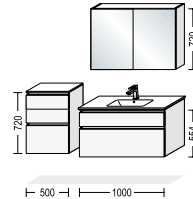

NBSET120-002

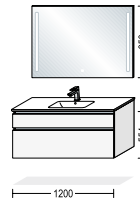

NBSET150-002

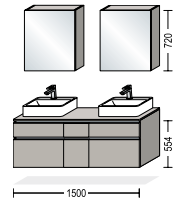

NBSET60-003

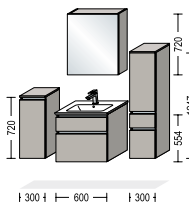

NBSET80-003



NBSET100-003

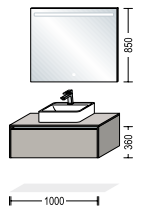

NBSET120-003

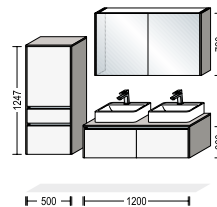

NBSET100-004

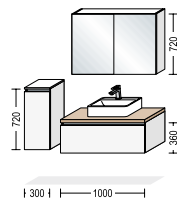

NBSET120-004

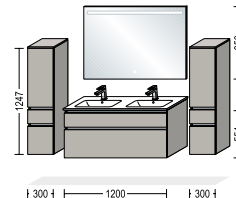

NBSET100-005

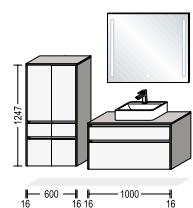

SPEZIFIKATIONEN SPECIFICATIONS

mit Griff with handle

Waschtischgröße Hand basin size

600 mm

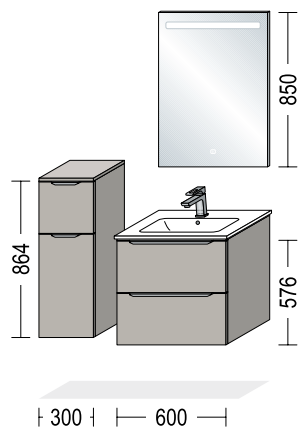

BSET60-001

1 x BSA 30-86

Badezimmer-Sideboard, 1 Auszug, 1 Tür, 1 Einlegeboden, 320 mm tief, 300 mm breit, 864 mm hoch
Bathroom sideboard, 1 pull-out, 1 door, 1 shelf, 320 mm deep, 300 mm wide, 864 mm high

1 x ADB16-35

Abdeckboden, 16 mm stark, 346 mm tief, 303 mm breit
Top shelf, 16 mm thick, 346 mm deep, 303 mm wide

1 x BWASA 60-58

Badezimmer-Waschtischschrank, 1 Innenblende, 1 Schubkasten mit Auszugsblende, 1 Auszug, 461 mm tief, 600 mm breit, 576 mm hoch
Bathroom vanity unit, 1 internal panel, 1 drawer with pull-out panel, 1 pull-out, 461 mm deep, 600 mm wide, 576 mm high

1 x 87706

Waschtisch MEGX 600C, 614 mm breit, 492 mm hoch, 142 mm tief
Hand basin MEGX 600C, 614 mm wide, 492 mm high, 142 mm deep

1 x SPLH 60

Spiegel mit horizontalem LED-Lichtfenster, 24 mm tief, 600 mm breit, 850 mm hoch
Mirror with horizontal LED light window, 24 mm deep, 600 mm wide, 850 mm high



BSET60-002

1 x BWSA 60-43

Badezimmer-Waschtischschrank, 1 Schubkasten, 1 Auszug, 461 mm tief, 600 mm breit, 432 mm hoch
Bathroom vanity unit, 1 drawer, 1 pull-out, 461 mm deep, 600 mm wide, 432 mm high

1 x ADB16-59

Abdeckboden, 16 mm stark, 487 mm tief, 603 mm breit
Top shelf, 16 mm thick, 487 mm deep, 603 mm wide

1 x 87725

Aufsatzwaschtisch WB 0002 W 520C, 450 mm tief, 519 mm breit, 162 mm hoch
Surface-mounted hand basin WB 0002 W 520C, 450 mm deep, 519 mm wide, 162 mm high

1 x SPLV 60

Spiegel mit vertikalen LED-Lichtfenstern, 24 mm tief, 600 mm breit, 850 mm hoch
Mirror with vertical LED light windows, 24 mm deep, 600 mm wide, 850 mm high

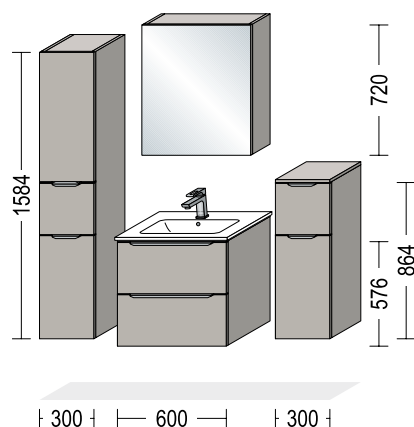

BSET60-003

1 x BMA 30-158

Badezimmer-Midischrank, 1 Tür, 1 Auszug, 1 Tür, 3 Einlegeböden, 320 mm tief, 300 mm breit, 1584 mm hoch
Bathroom Midi unit, 1 door, 1 pull-out, 1 door, 3 shelves, 320 mm deep, 300 mm wide, 1584 mm high

1 x BWASA 60-58

Badezimmer-Waschtischschrank, 1 Innenblende, 1 Schubkasten mit Auszugsblende, 1 Auszug, 461 mm tief, 600 mm breit, 576 mm hoch
Bathroom vanity unit, 1 internal panel, 1 drawer with pull-out panel, 1 pull-out, 461 mm deep, 600 mm wide, 576 mm high

1 x 87706

Waschtisch MEGX 600C, 492 mm tief, 614 mm breit, 142 mm hoch
Hand basin MEGX 600C, 492 mm deep, 614 mm wide, 142 mm high

1 x WBSP 60-02

Spiegelschrank, 1 Spiegeltür, 2 Glaseinlegeböden, 202 mm tief, 600 mm breit, 720 mm hoch
Mirrored bathroom cabinet, 1 mirrored door, 2 glass shelves, 202 mm deep, 600 mm wide, 720 mm high

1 x BSA 30-86

Badezimmer-Sideboard, 1 Auszug, 1 Tür, 1 Einlegeboden, 320 mm tief, 300 mm breit, 864 mm hoch
Bathroom sideboard, 1 pull-out, 1 door, 1 shelf, 320 mm deep, 300 mm wide, 864 mm high

1 x ADB16-35

Abdeckboden, 16 mm stark, 346 mm tief, 303 mm breit
Top shelf, 16 mm thick, 346 mm deep, 303 mm wide

Die Planungsvorschläge enthalten keine Armaturen, Leuchten, Griffleisten-Mehrpreise oder Steckdosen. Diese müssen zusätzlich zur Set-Artikelnnummer bestellt werden.

Planning suggestions do not include taps, lights, handle surcharges or sockets. These must be ordered in addition to the set item number.

Waschtischgröße Hand basin size

800 mm

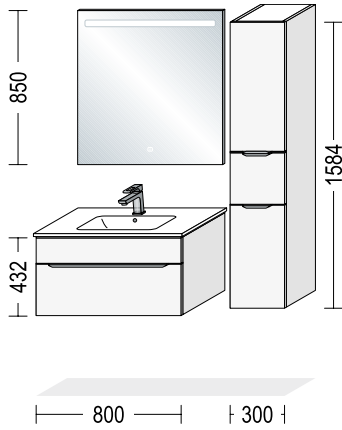

BSET80-001

1 x BWA 80-43

1 x 87708

1 x SPLH 80

1 x BMA 30-158

Badezimmer-Waschtischschrank, 1 feste Blende, 1 Auszug, 461 mm tief, 800 mm breit, 432 mm hoch
Bathroom vanity unit, 1 fixed panel, 1 pull-out, 461 mm deep, 800 mm wide, 432 mm high

Waschtisch MEGX 800C, 492 mm tief, 814 mm breit, 142 mm hoch
Hand basin MEGX 800C, 492 mm deep, 814 mm wide, 142 mm high

Spiegel mit horizontalem LED-Lichtfenster, 24 mm tief, 800 mm breit, 850 mm hoch
Mirror with horizontal LED light window, 24 mm deep, 800 mm wide, 850 mm high

Badezimmer-Midischrank, 1 Tür, 1 Auszug, 1 Tür, 3 Einlegeböden, 320 mm tief, 300 mm breit, 1584 mm hoch
Bathroom Midi unit, 1 door, 1 pull-out, 1 door, 3 shelves, 320 mm deep, 300 mm wide, 1584 mm high

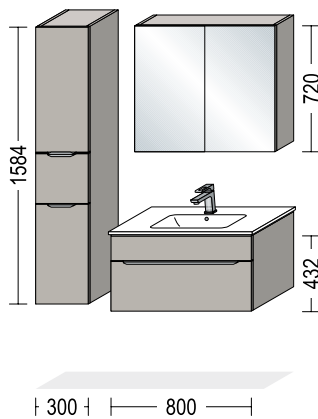

BSET80-002

1 x BMA 30-158

1 x BWA 80-43

1 x 87708

1 x WBSP 80-02

Badezimmer-Midischrank, 1 Tür, 1 Auszug, 1 Tür, 3 Einlegeböden, 320 mm tief, 300 mm breit, 1584 mm hoch
Bathroom Midi unit, 1 door, 1 pull-out, 1 door, 3 shelves, 320 mm deep, 300 mm wide, 1584 mm high

Badezimmer-Waschtischschrank, 1 feste Blende, 1 Auszug, 461 mm tief, 800 mm breit, 432 mm hoch
Bathroom vanity unit, 1 fixed panel, 1 pull-out, 461 mm deep, 800 mm wide, 432 mm high

Waschtisch MEGX 800C, 492 mm tief, 814 mm breit, 142 mm hoch
Hand basin MEGX 800C, 492 mm deep, 814 mm wide, 142 mm high

Spiegelschrank, 2 Spiegeltüren, 2 Glaseinlegeböden, 202 mm tief, 800 mm breit, 720 mm hoch
Mirrored bathroom cabinet, 2 mirrored doors, 2 glass shelves, 202 mm deep, 800 mm wide, 720 mm high

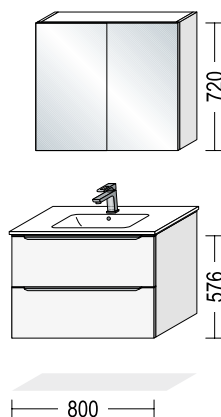

BSET80-003

1 x BWASA 80-58

1 x 87708

1 x WBSP 80-02

Badezimmer-Waschtischschrank, 1 Innenblende, 1 Schubkasten mit Auszugsblende, 1 Auszug, 461 mm tief, 800 mm breit, 576 mm hoch
Bathroom vanity unit, 1 internal panel, 1 drawer with pull-out panel, 1 pull-out, 461 mm deep, 800 mm wide, 576 mm high

Waschtisch MEGX 800C, 492 mm tief, 814 mm breit, 142 mm hoch
Hand basin MEGX 800C, 492 mm deep, 814 mm wide, 142 mm high

Spiegelschrank, 2 Spiegeltüren, 2 Glaseinlegeböden, 202 mm tief, 800 mm breit, 720 mm hoch
Mirrored bathroom cabinet, 2 mirrored doors, 2 glass shelves, 202 mm deep, 800 mm wide, 720 mm high

Die Planungsvorschläge enthalten keine Armaturen, Leuchten, Griffleisten-Mehrpreise oder Steckdosen. Diese müssen zusätzlich zur Set-Artikelnummer bestellt werden.

Planning suggestions do not include taps, lights, handle surcharges or sockets. These must be ordered in addition to the set item number.

SPEZIFIKATIONEN SPECIFICATIONS

Waschtischgröße Hand basin size

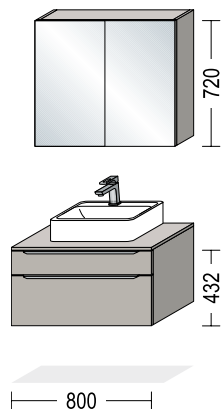
800 mm**BSET80-004**

1 x BWSA 80-43

Badezimmer-Waschtischschrank, 1 Schubkasten mit Holzrückwand, 1 Auszug, 461 mm tief, 800 mm breit, 432 mm hoch
Bathroom vanity unit, 1 drawer with wooden back panel, 1 pull-out, 461 mm deep, 800 mm wide, 432 mm high

1 x ADB16-59

Abdeckboden, 16 mm stark, 487 mm tief, 803 mm breit
Top shelf, 16 mm thick, 487 mm deep, 803 mm wide

1 x 87725

Aufsatzwaschtisch WB 0002 W 520C, 450 mm tief, 519 mm breit, 162 mm hoch
Surface-mounted hand basin WB 0002 W 520C, 450 mm deep, 519 mm wide, 162 mm high

1 x WBSP 80-02

Spiegelschrank, 2 Spiegeltüren, 2 Glaseinlegeböden, 202 mm tief, 800 mm breit, 720 mm hoch
Mirrored bathroom cabinet, 2 mirrored doors, 2 glass shelves, 202 mm deep, 800 mm wide, 720 mm high

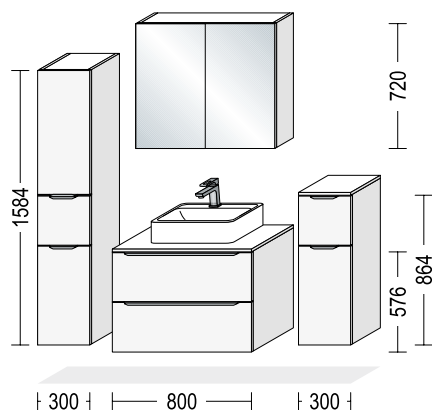
**BSET80-005**

1 x BMA 30-158

Badezimmer-Midischrank, 1 Tür, 1 Auszug, 1 Tür, 3 Einlegeböden, 320 mm tief, 300 mm breit, 1584 mm hoch
Bathroom Midi unit, 1 door, 1 pull-out, 1 door, 3 shelves, 320 mm deep, 300 mm wide, 1584 mm high

1 x BW2A 80-58

Badezimmer-Waschtischschrank, 2 Auszüge, 461 mm tief, 800 mm breit, 576 mm hoch
Bathroom vanity unit, 2 pull-outs, 461 mm deep, 800 mm wide, 576 mm high

1 x ADB16-59

Abdeckboden, 16 mm stark, 487 mm tief, 803 mm breit
Top shelf, 16 mm thick, 487 mm deep, 803 mm wide

1 x 87726

Aufsatzwaschtisch WB 0517 C 600C, 470 mm tief, 600 mm breit, 144 mm hoch
Surface-mounted hand basin WB 0517 C 600C, 470 mm deep, 600 mm wide, 144 mm high

1 x WBSP 80-02

Spiegelschrank, 2 Spiegeltüren, 2 Glaseinlegeböden, 202 mm tief, 800 mm breit, 720 mm hoch
Mirrored bathroom cabinet, 2 mirrored doors, 2 glass shelves, 202 mm deep, 800 mm wide, 720 mm high

1 x BSA 30-86

Badezimmer-Sideboard, 1 Auszug, 1 Tür, 1 Einlegeboden, 320 mm tief, 300 mm breit, 864 mm hoch
Bathroom sideboard, 1 pull-out, 1 door, 1 shelf, 320 mm deep, 300 mm wide, 864 mm high

1 x ADB16-35

Abdeckboden, 16 mm stark, 346 mm tief, 303 mm breit
Top shelf, 16 mm thick, 346 mm deep, 303 mm wide

Die Planungsvorschläge enthalten keine Armaturen, Leuchten, Griffleisten-Mehrpreise oder Steckdosen. Diese müssen zusätzlich zur Set-Artikelnummer bestellt werden.

Planning suggestions do not include taps, lights, handle surcharges or sockets. These must be ordered in addition to the set item number.

Waschtischgröße Hand basin size

1000 mm

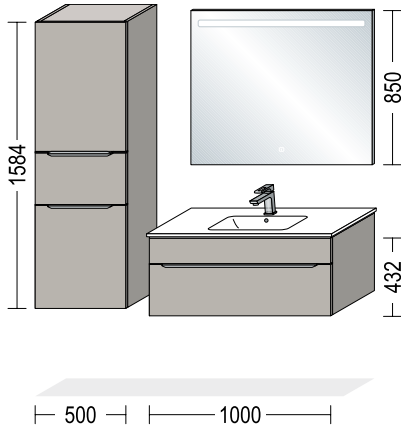

BSET100-001

1 x BMA 50-158

Badezimmer-Midischrank, 1 Tür, 1 Auszug, 1 Tür, 3 Einlegeböden,
320 mm tief, 500 mm breit, 1584 mm hoch
Bathroom Midi unit, 1 door, 1 pull-out, 1 door, 3 shelves,
320 mm deep, 500 mm wide, 1584 mm high

1 x BWA 100-43

Badezimmer-Waschtischschrank, 1 feste Blende, 1 Auszug,
461 mm tief, 1000 mm breit, 432 mm hoch
Bathroom vanity unit, 1 fixed panel, 1 pull-out,
461 mm deep, 1000 mm wide, 432 mm high

1 x 87710

Waschtisch MEGX 1000C, 492 mm tief, 1014 mm breit, 142 mm hoch
Hand basin MEGX 1000C, 492 mm deep, 1014 mm wide, 142 mm high

1 x SPLH 100

Spiegel mit horizontalem LED-Lichtfenster,
24 mm tief, 1000 mm breit, 850 mm hoch
Mirror with horizontal LED light window,
24 mm deep, 1000 mm wide, 850 mm high

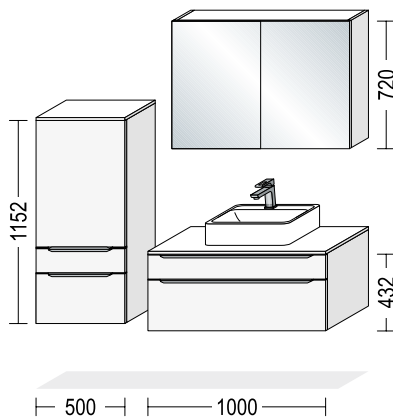

BSET100-002

1 x BMSA 50-115

Badezimmer-Midischrank, 1 Tür, 1 Schubkasten, 1 Auszug,
2 Einlegeböden, 320 mm tief, 500 mm breit, 1152 mm hoch
Bathroom Midi unit, 1 door, 1 drawer, 1 pull-out, 2 shelves,
320 mm deep, 500 mm wide, 1152 mm high

1 x ADB 16-35

Abdeckboden, 16 mm stark, 346 mm tief, 503 mm breit
Top shelf, 16 mm thick, 346 mm deep, 503 mm wide

1 x BWSA 100-43

Badezimmer-Waschtischschrank, 1 Schubkasten, 1 Auszug,
461 mm tief, 1000 mm breit, 432 mm hoch
Bathroom vanity unit, 1 drawer, 1 pull-out,
461 mm deep, 1000 mm wide, 432 mm high

1 x 87726

Aufsatzwaschtisch WB 0517 C 600C,
470 mm tief, 600 mm breit, 144 mm hoch
Surface-mounted hand basin WB 0517 C 600C,
470 mm deep, 600 mm wide, 144 mm high

1 x ADB16-59

Abdeckboden, 16 mm stark, 487 mm tief, 1003 mm breit
Top shelf, 16 mm thick, 487 mm deep, 1003 mm wide

1 x WBSP 100-02

Spiegelschrank, 2 Spiegeltüren, 2 Glaseinlegeböden,
202 mm tief, 1000 mm breit, 720 mm hoch
Mirrored bathroom cabinet, 2 mirrored doors, 2 glass shelves,
202 mm deep, 1000 mm wide, 720 mm high

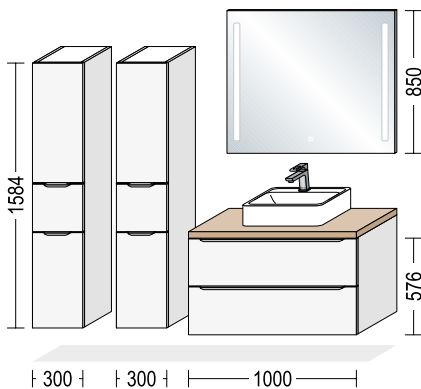

BSET100-003

2 x BMA 30-158

Badezimmer-Midischrank, 1 Tür, 1 Auszug, 1 Tür, 3 Einlegeböden,
320 mm tief, 300 mm breit, 1584 mm hoch
Bathroom Midi unit, 1 door, 1 pull-out, 1 door, 3 shelves,
320 mm deep, 300 mm wide, 1584 mm high

1 x BW2A 100-58

Badezimmer-Waschtischschrank, 2 Auszüge,
461 mm tief, 1000 mm breit, 576 mm hoch
Bathroom vanity unit, 2 pull-outs,
461 mm deep, 1000 mm wide, 576 mm high

1 x APD 60

Arbeitsplatte APD mit Dekorkante,
38 mm stark, 487 mm tief, 1003 mm breit
Worktop APD with décor edge,
38 mm thick, 487 mm deep, 1003 mm wide

1 x 87726

Aufsatzwaschtisch WB 0517 C 600C,
470 mm tief, 600 mm breit, 144 mm hoch
Surface-mounted hand basin WB 0517 C 600C,
470 mm deep, 600 mm wide, 144 mm high

1 x SPLV 100

Spiegel mit vertikalen LED-Lichtfenstern,
24 mm tief, 1000 mm breit, 850 mm hoch
Mirror with vertical LED light windows,
24 mm deep, 1000 mm wide, 850 mm high

Die Planungsvorschläge enthalten keine Armaturen, Leuchten, Griffleisten-Mehrpreise oder Steckdosen. Diese müssen zusätzlich zur Set-Artikelnummer bestellt werden.

Planning suggestions do not include taps, lights, handle surcharges or sockets. These must be ordered in addition to the set item number.

SPEZIFIKATIONEN SPECIFICATIONS

Waschtischgröße Hand basin size

1200 mm

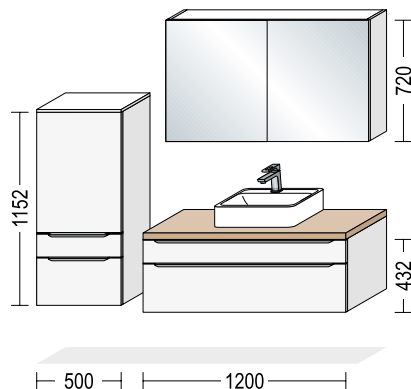

BSET120-001

1 x BMSA 50-115

Badezimmer-Midischrank, 1 Tür, 1 Schubkasten, 1 Auszug, 2 Einlegeböden, 320 mm tief, 500 mm breit, 1152 mm hoch
Bathroom Midi unit, 1 door, 1 drawer, 1 pull-out, 2 shelves, 320 mm deep, 500 mm wide, 1152 mm high

1 x ADB 16-35

Abdeckboden, 16 mm stark, 346 mm tief, 503 mm breit
Top shelf, 16 mm thick, 346 mm deep, 503 mm wide

1 x BWSA 120-43

Badezimmer-Waschtischschrank, 1 Schubkasten, 1 Auszug, 461 mm tief, 1200 mm breit, 432 mm hoch
Bathroom vanity unit, 1 drawer, 1 pull-out, 461 mm deep, 1200 mm wide, 432 mm high

1 x APD 60

Arbeitsplatte APD mit Dekorkante, 38 mm stark, 487 mm tief, 1203 mm breit
Worktop APD with décor edge, 38 mm thick, 487 mm deep, 1203 mm wide

1 x 87726

Aufsatzwaschtisch WB 0517 C 600C, 470 mm tief, 600 mm breit, 144 mm hoch
Surface-mounted hand basin WB 0517 C 600C, 470 mm deep, 600 mm wide, 144 mm high

1 x WBSP 120-02

Spiegelschrank, 2 Spiegeltüren, 2 Glaseinlegeböden, 202 mm tief, 1200 mm breit, 720 mm hoch
Mirrored bathroom cabinet, 2 mirrored doors, 2 glass shelves, 202 mm deep, 1200 mm wide, 720 mm high

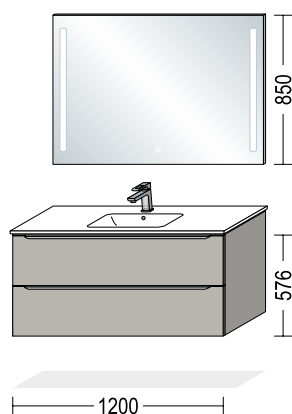

BSET120-002

1 x BWASA 120-58

Badezimmer-Waschtischschrank, 1 Innenblende, 1 Schubkasten mit Auszugsblende, 1 Auszug, 461 mm tief, 1200 mm breit, 576 mm hoch
Bathroom vanity unit, 1 internal panel, 1 drawer with pull-out panel, 1 pull-out, 461 mm deep, 1200 mm wide, 576 mm high

1 x 87712

Waschtisch MEGX 1200C, 492 mm tief, 1214 mm breit, 142 mm hoch
Hand basin MEGX 1200C, 492 mm deep, 1214 mm wide, 142 mm high

1 x SPLV 120

Spiegel mit vertikalen LED-Lichtfenstern, 24 mm tief, 1200 mm breit, 850 mm hoch
Mirror with vertical LED light windows, 24 mm deep, 1200 mm wide, 850 mm high

Waschtischgröße Hand basin size

1200 mm

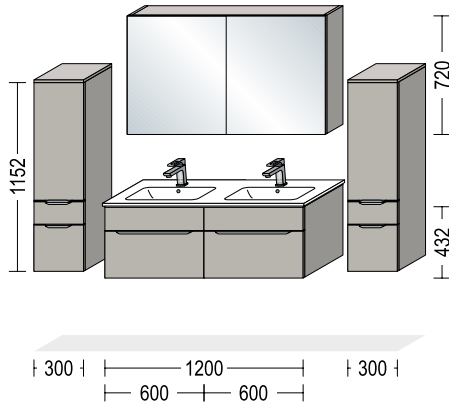

BSET120-003

1 x BMSA 30-115

Badezimmer-Midischrank, 1 Tür, 1 Schubkasten, 1 Auszug, 2 Einlegeböden, 320 mm tief, 300 mm breit, 1152 mm hoch
Bathroom Midi unit, 1 door, 1 drawer, 1 pull-out, 2 shelves, 320 mm deep, 300 mm wide, 1152 mm high

2 x BWA 60-43

Badezimmer-Waschtischschrank, 1 feste Blende, 1 Auszug, 461 mm tief, 600 mm breit, 432 mm hoch
Bathroom vanity unit, 1 fixed panel, 1 pull-out, 461 mm deep, 600 mm wide, 432 mm high

1 x 87722

Doppelwaschtisch MEGX 1200D, 492 mm tief, 1214 mm breit, 142 mm hoch
Double hand basin MEGX 1200D, 492 mm deep, 1214 mm wide, 142 mm high

1 x WBSP 120-02

Spiegelschrank, 2 Spiegeltüren, 2 Glaseinlegeböden, 202 mm tief, 1200 mm breit, 720 mm hoch
Mirrored bathroom cabinet, 2 mirrored doors, 2 glass shelves, 202 mm deep, 1200 mm wide, 720 mm high

1 x BMSA 30-115

Badezimmer-Midischrank, 1 Tür, 1 Schubkasten, 1 Auszug, 2 Einlegeböden, 320 mm tief, 300 mm breit, 1152 mm hoch
Bathroom Midi unit, 1 door, 1 drawer, 1 pull-out, 2 shelves, 320 mm deep, 300 mm wide, 1152 mm high

2 x ADB 16-35

Abdeckboden, 16 mm stark, 346 mm tief, 303 mm breit
Top shelf, 16 mm thick, 346 mm deep, 303 mm wide

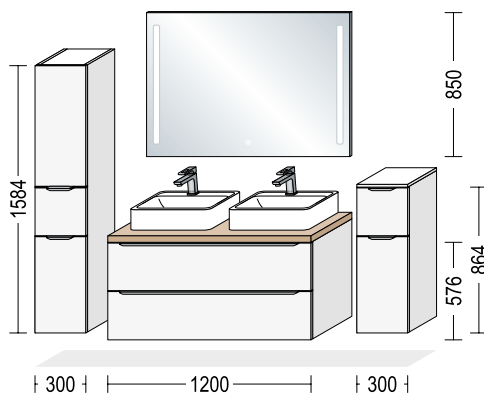

BSET120-004

1 x BMA 30-158

Badezimmer-Midischrank, 1 Tür, 1 Auszug, 1 Tür, 3 Einlegeböden, 320 mm tief, 300 mm breit, 1584 mm hoch
Bathroom Midi unit, 1 door, 1 pull-out, 1 door, 3 shelves, 320 mm deep, 300 mm wide, 1584 mm high

1 x BW2A 120-58

Badezimmer-Waschtischschrank, 2 Auszüge, 461 mm tief, 1200 mm breit, 576 mm hoch
Bathroom vanity unit, 2 pull-outs, 461 mm deep, 1200 mm wide, 576 mm high

1 x APD 60

Arbeitsplatte APD mit Dekorkante, 38 mm stark, 487 mm tief, 1203 mm breit
Worktop APD with décor edge, 38 mm thick, 487 mm deep, 1203 mm wide

2 x 87725

Aufsatzwaschtisch WB 0002 W 520C, 450 mm tief, 519 mm breit, 162 mm hoch
Surface-mounted hand basin WB 0002 W 520C, 450 mm deep, 519 mm wide, 162 mm high

1 x SPLV 120

Spiegel mit vertikalen LED-Lichtfenstern, 24 mm tief, 1200 mm breit, 850 mm hoch
Mirror with vertical LED light windows, 24 mm deep, 1200 mm wide, 850 mm high

1 x BSA 30-86

Badezimmer-Sideboard, 1 Auszug, 1 Tür, 1 Einlegeboden, 320 mm tief, 300 mm breit, 864 mm hoch
Bathroom sideboard, 1 pull-out, 1 door, 1 shelf, 320 mm deep, 300 mm wide, 864 mm high

1 x ADB16-35

Abdeckboden, 16 mm stark, 346 mm tief, 303 mm breit
Top shelf, 16 mm thick, 346 mm deep, 303 mm wide

Die Planungsvorschläge enthalten keine Armaturen, Leuchten, Griffleisten-Mehrpreise oder Steckdosen. Diese müssen zusätzlich zur Set-Artikelnummer bestellt werden.

Planning suggestions do not include taps, lights, handle surcharges or sockets. These must be ordered in addition to the set item number.

SPEZIFIKATIONEN SPECIFICATIONS

Waschtischgröße Hand basin size

1500 mm

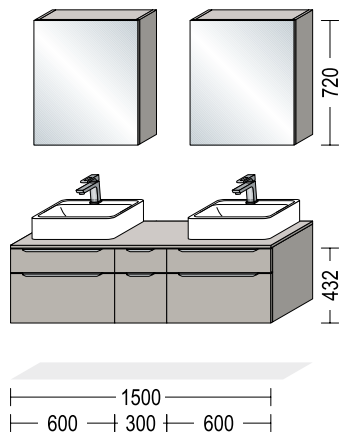
**BSET150-001**

1 x BWSA 60-43

Badezimmer-Waschtischschrank, 1 Schubkasten, 1 Auszug
 461 mm tief, 600 mm breit, 432 mm hoch
 Bathroom vanity unit, 1 drawer, 1 pull-out,
 461 mm deep, 600 mm wide, 432 mm high

1 x BUSA 30-43

Badezimmer-Auszugschrank, 1 Schubkasten, 1 Auszug
 461 mm tief, 300 mm breit, 432 mm hoch
 Bathroom Pull-out unit, 1 drawer, 1 pull-out,
 461 mm deep, 300 mm wide, 432 mm high

1 x BWSA 60-43

Badezimmer-Waschtischschrank, 1 Schubkasten, 1 Auszug
 461 mm tief, 600 mm breit, 432 mm hoch
 Bathroom vanity unit, 1 drawer, 1 pull-out,
 461 mm deep, 600 mm wide, 432 mm high

1 x ADB16-59

Abdeckboden, 16 mm stark, 487 mm tief, 1503 mm breit
 Top shelf, 16 mm thick, 487 mm deep, 1503 mm wide

2 x 87726

Aufsatzwaschtisch WB 0517 C 600C,
 470 mm tief, 600 mm breit, 144 mm hoch
 Surface-mounted hand basin WB 0517 C 600C,
 470 mm deep, 600 mm wide, 144 mm high

2 x WBSP 60-02

Spiegelschrank, 1 Spiegeltür, 2 Glaseinlegeböden
 202 mm tief, 600 mm breit, 720 mm hoch
 Mirrored bathroom cabinet, 1 mirrored door, 2 glass shelves,
 202 mm deep, 600 mm wide, 720 mm high

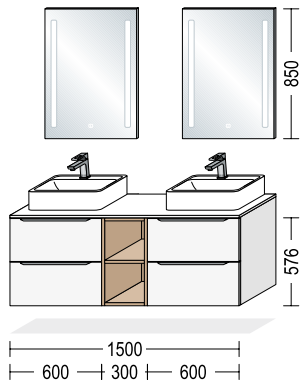
**BSET150-002**

1 x BW2A 60-58

Badezimmer-Waschtischschrank, 2 Auszüge
 461 mm tief, 600 mm breit, 576 mm hoch
 Bathroom vanity unit, 2 pull-outs,
 461 mm deep, 600 mm wide, 576 mm high

1 x BUR 30-58

Badezimmer-Unterschrankregal, 1 fester Boden
 482 mm tief, 300 mm breit, 576 mm hoch
 Bathroom open shelf base unit, 1 fixed shelf,
 482 mm deep, 300 mm wide, 576 mm high

1 x BW2A 60-58

Badezimmer-Waschtischschrank, 2 Auszüge
 461 mm tief, 600 mm breit, 576 mm hoch
 Bathroom vanity unit, 2 pull-outs,
 461 mm deep, 600 mm wide, 576 mm high

1 x ADB16-59

Abdeckboden, 16 mm stark, 487 mm tief, 1503 mm breit
 Top shelf, 16 mm thick, 487 mm deep, 1503 mm wide

2 x 87725

Aufsatzwaschtisch WB 0002 W 520C,
 450 mm tief, 519 mm breit, 162 mm hoch
 Surface-mounted hand basin WB 0002 W 520C,
 450 mm deep, 519 mm wide, 162 mm high

2 x SPLV 60

Spiegel mit vertikalen LED-Lichtfenstern
 24 mm tief, 600 mm breit, 850 mm hoch
 Mirror with vertical LED light windows,
 24 mm deep, 600 mm wide, 850 mm high

Die Planungsvorschläge enthalten keine Armaturen, Leuchten, Griffleisten-Mehrpreise oder Steckdosen. Diese müssen zusätzlich zur Set-Artikelnummer bestellt werden.

Planning suggestions do not include taps, lights, handle surcharges or sockets. These must be ordered in addition to the set item number.

SPEZIFIKATIONEN SPECIFICATIONS

grifflos handleless

Waschtischgröße Hand basin size

600 mm

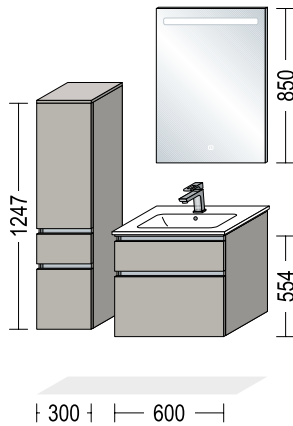

NBSET60-001

1 x NBMSA 30-125

Badezimmer-Midischrank, 1 Tür, 1 Schubkasten, 1 Auszug, 2 Einlegeböden, 320 mm tief, 300 mm breit, 1247 mm hoch
Bathroom Midi unit, 1 door, 1 drawer, 1 pull-out, 2 shelves, 320 mm deep, 300 mm wide, 1247 mm high

1 x ADB 16-35

Abdeckboden, 16 mm stark, 343 mm tief, 303 mm breit
Top shelf, 16 mm thick, 343 mm deep, 303 mm wide

1 x NBWA 60-55

Badezimmer-Waschtischschrank, 1 feste Blende, 1 Auszug, 461 mm tief, 600 mm breit, 554 mm hoch
Bathroom vanity unit, 1 fixed panel, 1 pull-out, 461 mm deep, 600 mm wide, 554 mm high

1 x 87706

Waschtisch MEGX 600C, 492 mm tief, 614 mm breit, 142 mm hoch
Hand basin MEGX 600C, 492 mm deep, 614 mm wide, 142 mm high

1 x SPLH 60

Spiegel mit horizontalem LED-Lichtfenster, 24 mm tief, 600 mm breit, 850 mm hoch
Mirror with horizontal LED light window, 24 mm deep, 600 mm wide, 850 mm high



NBSET60-002

1 x NBWA 60-55

Badezimmer-Waschtischschrank, 1 feste Blende, 1 Auszug, 461 mm tief, 600 mm breit, 554 mm hoch
Bathroom vanity unit, 1 fixed panel, 1 pull-out, 461 mm deep, 600 mm wide, 554 mm high

1 x 87706

Waschtisch MEGX 600C, 492 mm tief, 614 mm breit, 142 mm hoch
Hand basin MEGX 600C, 492 mm deep, 614 mm wide, 142 mm high

1 x SPLH 60

Spiegel mit horizontalem LED-Lichtfenster, 24 mm tief, 600 mm breit, 850 mm hoch
Mirror with horizontal LED light window, 24 mm deep, 600 mm wide, 850 mm high

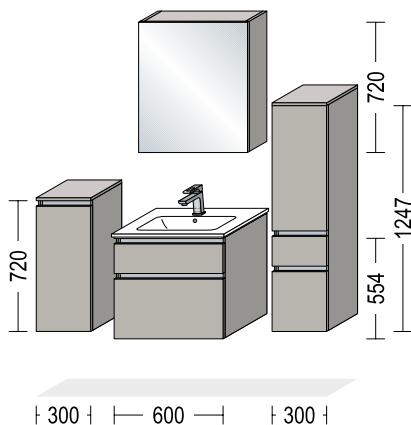

NBSET60-003

1 x NBS 30-72

Badezimmer-Sideboard, 1 Tür, 2 Einlegeböden, 320 mm tief, 300 mm breit, 720 mm hoch
Bathroom sideboard, 1 door, 2 shelves, 320 mm deep, 300 mm wide, 720 mm high

1 x ADB 16-35

Abdeckboden, 16 mm stark, 343 mm tief, 303 mm breit
Top shelf, 16 mm thick, 343 mm deep, 303 mm wide

1 x NBWA 60-55

Badezimmer-Waschtischschrank, 1 feste Blende, 1 Auszug, 461 mm tief, 600 mm breit, 554 mm hoch
Bathroom vanity unit, 1 fixed panel, 1 pull-out, 461 mm deep, 600 mm wide, 554 mm high

1 x 87706

Waschtisch MEGX 600C, 492 mm tief, 614 mm breit, 142 mm hoch
Hand basin MEGX 600C, 492 mm deep, 614 mm wide, 142 mm high

1 x WBSP 60-02

Spiegelschrank, 1 Spiegeltür, 2 Glaseinlegeböden, 202 mm tief, 600 mm breit, 720 mm hoch
Mirrored bathroom cabinet, 1 mirrored door, 2 glass shelves, 202 mm deep, 600 mm wide, 720 mm high

1 x NBMSA 30-125

Badezimmer-Midischrank, 1 Tür, 1 Schubkasten, 1 Auszug, 2 Einlegeböden, 320 mm tief, 300 mm breit, 1247 mm hoch
Bathroom Midi unit, 1 door, 1 drawer, 1 pull-out, 2 shelves, 320 mm deep, 300 mm wide, 1247 mm high

1 x ADB 16-35

Abdeckboden, 16 mm stark, 343 mm tief, 303 mm breit
Top shelf, 16 mm thick, 343 mm deep, 303 mm wide

Die Planungsvorschläge enthalten keine Armaturen, Leuchten oder Steckdosen. Diese müssen zusätzlich zur Set-Artikelnummer bestellt werden.

The planning suggestions do not include taps, lights or sockets. These must be ordered in addition to the set item number.

SPEZIFIKATIONEN SPECIFICATIONS

grifflos handleless

Waschtischgröße Hand basin size

800 mm

60-61

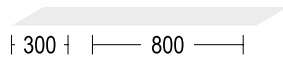
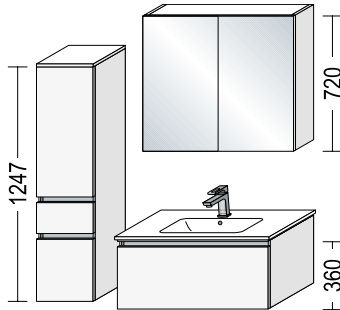

NBSET80-001

1 x NBMSA 30-125

Badezimmer-Midischrank, 1 Tür, 1 Schubkasten, 1 Auszug, 2 Einlegeböden, 320 mm tief, 300 mm breit, 1247 mm hoch
Bathroom Midi unit, 1 door, 1 drawer, 1 pull-out, 2 shelves, 320 mm deep, 300 mm wide, 1247 mm high

1 x ADB16-35

Abdeckboden, 16 mm stark, 343 mm tief, 303 mm breit
Top shelf, 16 mm thick, 343 mm deep, 303 mm wide

1 x NBWBA 80-36

Badezimmer-Waschtischschrank, 1 Innenblende, 1 Auszug, 461 mm tief, 800 mm breit, 360 mm hoch
Bathroom vanity unit, 1 internal panel, 1 pull-out, 461 mm deep, 800 mm wide, 360 mm high

1 x 87708

Waschtisch MEGX 800C, 492 mm tief, 814 mm breit, 142 mm hoch
Hand basin MEGX 800C, 492 mm deep, 814 mm wide, 142 mm high

1 x WBSP 80-02

Spiegelschrank, 2 Spiegeltüren, 2 Glaseinlegeböden, 202 mm tief, 800 mm breit, 720 mm hoch
Mirrored bathroom cabinet, 2 mirrored doors, 2 glass shelves, 202 mm deep, 800 mm wide, 720 mm high

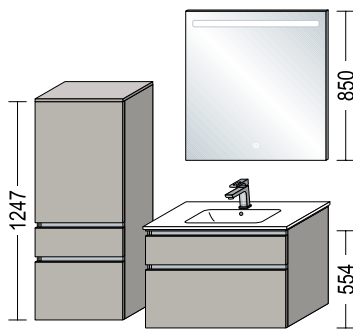

NBSET80-002

1 x NBMSA 50-125

Badezimmer-Midischrank, 1 Tür, 1 Schubkasten, 1 Auszug, 2 Einlegeböden, 320 mm tief, 500 mm breit, 1247 mm hoch
Bathroom Midi unit, 1 door, 1 drawer, 1 pull-out, 2 shelves, 320 mm deep, 500 mm wide, 1247 mm high

1 x ADB16-35

Abdeckboden, 16 mm stark, 343 mm tief, 503 mm breit
Top shelf, 16 mm thick, 343 mm deep, 503 mm wide

1 x NBWA 80-55

Badezimmer-Waschtischschrank, 1 feste Blende, 1 Auszug, 461 mm tief, 800 mm breit, 554 mm hoch
Bathroom vanity unit, 1 fixed panel, 1 pull-out, 461 mm deep, 800 mm wide, 554 mm high

1 x 87708

Waschtisch MEGX 800C, 492 mm tief, 814 mm breit, 142 mm hoch
Hand basin MEGX 800C, 492 mm deep, 814 mm wide, 142 mm high

1 x SPLH 80

Spiegel mit horizontalem LED-Lichtfenster, 24 mm tief, 800 mm breit, 850 mm hoch
Mirror with horizontal LED light window, 24 mm deep, 800 mm wide, 850 mm high

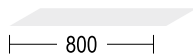
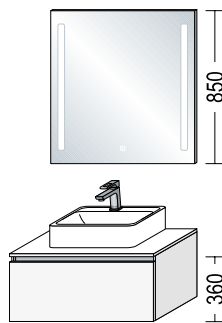

NBSET80-003

1 x NBWA 80-36

Badezimmer-Waschtischschrank, 461 mm tief, 800 mm breit, 360 mm hoch
Bathroom vanity unit, 461 mm deep, 800 mm wide, 360 mm high

1 x ADB16-59

Abdeckboden, 16 mm stark, 484 mm tief, 803 mm breit
Top shelf, 16 mm thick, 484 mm deep, 803 mm wide

1 x 87726

Aufsatzwaschtisch WB 0517 C 600C, 470 mm tief, 600 mm breit, 144 mm hoch
Surface-mounted hand basin WB 0517 C 600C, 470 mm deep, 600 mm wide, 144 mm high

1 x SPLV 80

Spiegel mit vertikalen LED-Lichtfenstern, 24 mm tief, 800 mm breit, 850 mm hoch
Mirror with vertical LED light windows, 24 mm deep, 800 mm wide, 850 mm high

Die Planungsvorschläge enthalten keine Armaturen, Leuchten oder Steckdosen. Diese müssen zusätzlich zur Set-Artikelnummer bestellt werden.

The planning suggestions do not include taps, lights or sockets. These must be ordered in addition to the set item number.

Waschtischgröße Hand basin size

1000 mm

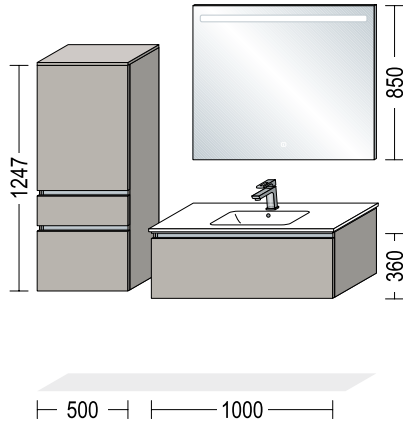

NBSET100-001

1 x NBMSA 50-125

Badezimmer-Midischrank, 1 Tür, 1 Schubkasten, 1 Auszug, 2 Einlegeböden, 320 mm tief, 500 mm breit, 1247 mm hoch
Bathroom Midi unit, 1 door, 1 drawer, 1 pull-out, 2 shelves, 320 mm deep, 500 mm wide, 1247 mm high

1 x ADB16-35

Abdeckboden, 16 mm stark, 343 mm tief, 503 mm breit
Top shelf, 16 mm thick, 343 mm deep, 503 mm wide

1 x NBWBA 100-36

Badezimmer-Waschtischschrank, 1 Innenblende, 1 Auszug, 461 mm tief, 1000 mm breit, 360 mm hoch
Bathroom vanity unit, 1 internal panel, 1 pull-out, 461 mm deep, 1000 mm wide, 360 mm high

1 x 87710

Waschtisch MEGX 1000C, 492 mm tief, 1014 mm breit, 142 mm hoch
Hand basin MEGX 1000C, 492 mm deep, 1014 mm wide, 142 mm high

1 x SPLH 100

Spiegel mit horizontalem LED-Lichtfenster, 24 mm tief, 1000 mm breit, 850 mm hoch
Mirror with horizontal LED light window, 24 mm deep, 1000 mm wide, 850 mm high

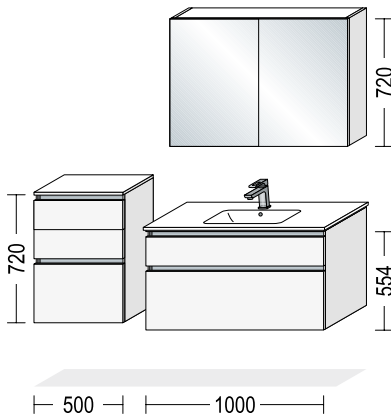

NBSET100-002

1 x NBS2SA 50-72

Badezimmer-Sideboard, 2 Schubkästen, 1 Auszug, 320 mm tief, 500 mm breit, 720 mm hoch
Bathroom sideboard, 2 drawers, 1 pull-out, 320 mm deep, 500 mm wide, 720 mm high

1 x ADB16-35

Abdeckboden, 16 mm stark, 343 mm tief, 503 mm breit
Top shelf, 16 mm thick, 343 mm deep, 503 mm wide

1 x NBWA 100-55

Badezimmer-Waschtischschrank, 1 feste Blende, 1 Auszug, 461 mm tief, 1000 mm breit, 554 mm hoch
Bathroom vanity unit, 1 fixed panel, 1 pull-out, 461 mm deep, 1000 mm wide, 554 mm high

1 x 87710

Waschtisch MEGX 1000C, 492 mm tief, 1014 mm breit, 142 mm hoch
Hand basin MEGX 1000C, 492 mm deep, 1014 mm wide, 142 mm high

1 x WBSP 100-02

Spiegelschrank, 2 Spiegeltüren, 2 Glaseinlegeböden, 202 mm tief, 1000 mm breit, 720 mm hoch
Mirrored bathroom cabinet, 2 mirrored doors, 2 glass shelves, 202 mm deep, 1000 mm wide, 720 mm high

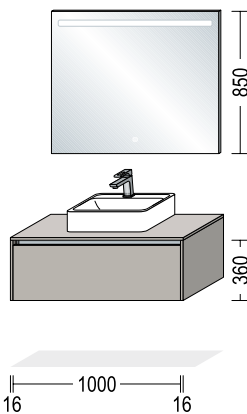

NBSET100-003

1 x NBWA 100-36

Badezimmer-Waschtischschrank, 1 Auszug, 461 mm tief, 1000 mm breit, 360 mm hoch
Bathroom vanity unit, 1 pull-out, 461 mm deep, 1000 mm wide, 360 mm high

2 x NBWU 16-36

Abschlusswangen, 16 mm stark, 360 mm hoch, 482 mm tief
End uprights, 16 mm thick, 360 mm high, 482 mm deep

1 x ADB16-59

Abdeckboden, 16 mm stark, 484 mm tief, 1035 mm breit
Top shelf, 16 mm thick, 484 mm deep, 1035 mm wide

1 x 87726

Aufsatzwaschtisch WB 0517 C 600C, 470 mm tief, 600 mm breit, 144 mm hoch
Surface-mounted hand basin WB 0517 C 600C, 470 mm deep, 600 mm wide, 144 mm high

1 x SPLH 100

Spiegel mit horizontalem LED-Lichtfenster, 24 mm tief, 1000 mm breit, 850 mm hoch
Mirror with horizontal LED light window, 24 mm deep, 1000 mm wide, 850 mm high

Die Planungsvorschläge enthalten keine Armaturen, Leuchten oder Steckdosen. Diese müssen zusätzlich zur Set-Artikelnummer bestellt werden.

The planning suggestions do not include taps, lights or sockets. These must be ordered in addition to the set item number.

SPEZIFIKATIONEN SPECIFICATIONS

grifflos handleless

Waschtischgröße Hand basin size

1000 mm

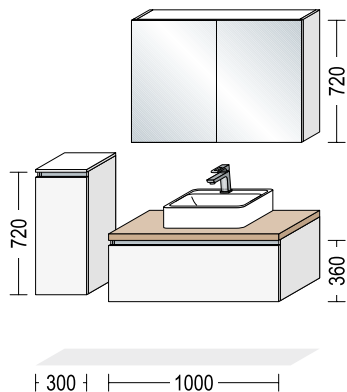

NBSET100-004

1 x NBS 30-72

Badzimmer-Sideboard, 1 Tür, 2 Einlegeböden,
320 mm tief, 300 mm breit, 720 mm hoch
Bathroom sideboard, 1 door, 2 shelves,
320 mm deep, 300 mm wide, 720 mm high

1 x ADB16-35

Abdeckboden, 16 mm stark, 343 mm tief, 303 mm breit
Top shelf, 16 mm thick, 343 mm deep, 303 mm wide

1 x NBWA 100-36

Badzimmer-Waschtischschrank, 1 Auszug,
461 mm tief, 1000 mm breit, 360 mm hoch
Bathroom vanity unit, 1 pull-out,
461 mm deep, 1000 mm wide, 360 mm high

1 x APD 60

Arbeitsplatte APD mit Dekorkante,
38 mm stark, 485 mm tief, 1003 mm breit
Worktop APD with décor edge,
38 mm thick, 485 mm deep, 1003 mm wide

1 x 87725

Aufsatzwaschtisch WB 0002 W 520C,
450 mm tief, 519 mm breit, 162 mm hoch
Surface-mounted hand basin WB 0002 W 520C,
450 mm deep, 519 mm wide, 162 mm high

1 x WBSP 100-02

Spiegelschrank, 2 Spiegeltüren, 2 Glaseinlegeböden,
202 mm tief, 1000 mm breit, 720 mm hoch
Mirrored bathroom cabinet, 2 mirrored doors, 2 glass shelves,
202 mm deep, 1000 mm wide, 720 mm high

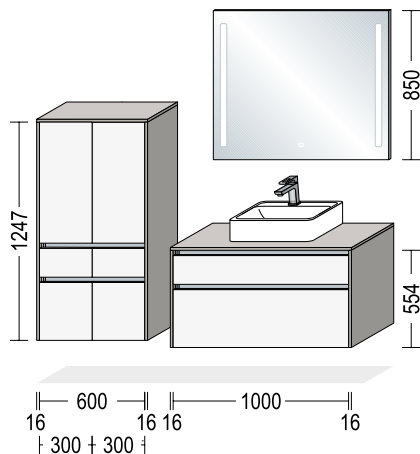

NBSET100-005

2 x NBMSA 30-125

Badzimmer-Midischrank, 1 Tür, 1 Schubkasten, 1 Auszug,
2 Einlegeböden, 320 mm tief, 300 mm breit, 1247 mm hoch
Bathroom Midi unit, 1 door, 1 drawer, 1 pull-out, 2 shelves,
320 mm deep, 300 mm wide, 1247 mm high

1 x ADB16-35

Abdeckboden, 16 mm stark, 343 mm tief, 635 mm breit
Top shelf, 16 mm thick, 343 mm deep, 635 mm wide

2 x NBMW16-125

Abschlusswangen, 16 mm stark, 341 mm tief, 1247 mm breit
End uprights, 16 mm thick, 341 mm deep, 1247 mm wide

1 x NBWSA 100-55

Badzimmer-Waschtischschrank, 1 Schubkasten, 1 Auszug,
461 mm tief, 1000 mm breit, 554 mm hoch
Bathroom vanity unit, 1 drawer, 1 pull-out,
461 mm deep, 1000 mm wide, 554 mm high

1 x ADB16-59

Abdeckboden, 16 mm stark, 484 mm tief, 1035 mm breit
Top shelf, 16 mm thick, 484 mm deep, 1035 mm wide

1 x 87726

Aufsatzwaschtisch WB 0517 C 600C,
470 mm tief, 600 mm breit, 144 mm hoch
Surface-mounted hand basin WB 0517 C 600C,
470 mm deep, 600 mm wide, 144 mm high

2 x NBW16-55

Abschlusswangen, 16 mm stark, 482 mm tief, 554 mm hoch
End uprights, 16 mm thick, 482 mm deep, 554 mm high

1 x SPLV 100

Spiegel mit vertikalen LED-Lichtfenstern,
24 mm tief, 1000 mm breit, 850 mm hoch
Mirror with vertical LED light windows,
24 mm deep, 1000 mm wide, 850 mm high

Die Planungsvorschläge enthalten keine Armaturen, Leuchten oder Steckdosen. Diese müssen zusätzlich zur Set-Artikelnummer bestellt werden.

The planning suggestions do not include taps, lights or sockets. These must be ordered in addition to the set item number.

Waschtischgröße Hand basin size

1200 mm

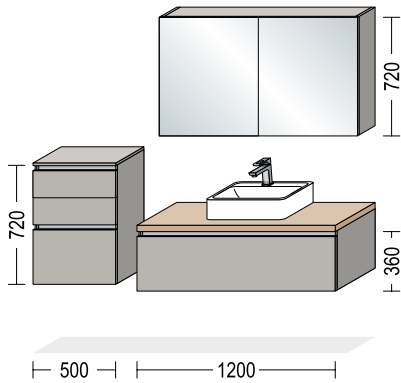

NBSET120-001

1 x NBS2SA 50-72

Badezimmer-Sideboard, 2 Schubkästen, 1 Auszug, 320 mm tief, 500 mm breit, 720 mm hoch
Bathroom sideboard, 2 drawers, 1 pull-out, 320 mm deep, 500 mm wide, 720 mm high

1 x ADB16-35

Abdeckboden, 16 mm stark, 343 mm tief, 503 mm breit
Top shelf, 16 mm thick, 343 mm deep, 503 mm wide

1 x NBWA 120-36

Badezimmer-Waschtischschrank, 1 Auszug, 461 mm tief, 1200 mm breit, 360 mm hoch
Bathroom vanity unit, 1 pull-out, 461 mm deep, 1200 mm wide, 360 mm high

1 x APD 60

Arbeitsplatte APD mit Dekorkante, 38 mm stark, 485 mm tief, 1203 mm breit
Worktop APD with décor edge, 38 mm thick, 485 mm deep, 1203 mm wide

1 x 87726

Aufsatzwaschtisch WB 0517 C 600C, 470 mm tief, 600 mm breit, 144 mm hoch
Surface-mounted hand basin WB 0517 C 600C, 470 mm deep, 600 mm wide, 144 mm high

1 x WBSP 120-02

Spiegelschrank, 2 Spiegeltüren, 2 Glaseinlegeböden, 202 mm tief, 1200 mm breit, 720 mm hoch
Mirrored bathroom cabinet, 2 mirrored doors, 2 glass shelves, 202 mm deep, 1200 mm wide, 720 mm high

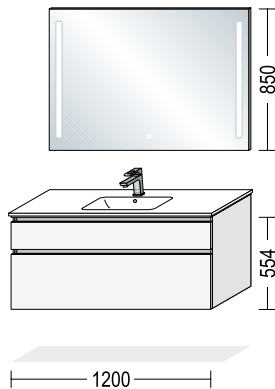

NBSET120-002

1 x NBWA 120-55

Badezimmer-Waschtischschrank, 1 feste Blende, 1 Auszug, 461 mm tief, 1200 mm breit, 554 mm hoch
Bathroom vanity unit, 1 fixed panel, 1 pull-out, 461 mm deep, 1200 mm wide, 554 mm high

1 x 87712

Waschtisch MEGX 1200C, 492 mm tief, 1214 mm breit, 142 mm hoch
Hand basin MEGX 1200C, 492 mm deep, 1214 mm wide, 142 mm high

1 x SPLV 120

Spiegel mit vertikalen LED-Lichtfenstern, 24 mm tief, 1200 mm breit, 850 mm hoch
Mirror with vertical LED light windows, 24 mm deep, 1200 mm wide, 850 mm high

Die Planungsvorschläge enthalten keine Armaturen, Leuchten oder Steckdosen. Diese müssen zusätzlich zur Set-Artikelnummer bestellt werden.

The planning suggestions do not include taps, lights or sockets. These must be ordered in addition to the set item number.

SPEZIFIKATIONEN SPECIFICATIONS

grifflos handleless

Waschtischgröße Hand basin size

1200 mm

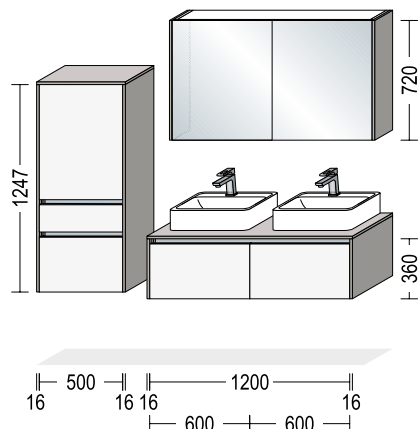

NBSET120-003

1 x NBMSA 50-125

Badezimmer-Midischrank, 1 Tür, 1 Schubkasten, 1 Auszug, 2 Einlegeböden, 320 mm tief, 500 mm breit, 1247 mm hoch
Bathroom Midi unit, 1 door, 1 drawer, 1 pull-out, 2 shelves, 320 mm deep, 500 mm wide, 1247 mm high

2 x NBMW16-125

Abschlusswangen, 16 mm stark, 341 mm tief, 1247 mm hoch
End uprights, 16 mm thick, 341 mm deep, 1247 mm high

1 x ADB16-35

Abdeckboden, 16 mm stark, 343 mm tief, 535 mm breit
Top shelf, 16 mm thick, 343 mm deep, 535 mm wide

2 x NBWA 60-36

Badezimmer-Waschtischschrank, 1 Auszug, 461 mm tief, 600 mm breit, 360 mm hoch
Bathroom vanity unit, 1 pull-out, 461 mm deep, 600 mm wide, 360 mm high

2 x NB UW16-36

Abschlusswangen, 16 mm stark, 482 mm tief, 360 mm hoch
End uprights, 16 mm thick, 482 mm deep, 360 mm high

1 x ADB16-59

Abdeckboden, 16 mm stark, 484 mm tief, 1235 mm breit
Top shelf, 16 mm thick, 484 mm deep, 1235 mm wide

2 x 87725

Aufsatzwaschtisch WB 0002 W 520C, 450 mm tief, 519 mm breit, 162 mm hoch
Surface-mounted hand basin WB 0002 W 520C, 450 mm deep, 519 mm wide, 162 mm high

1 x WBSP 120-02

Spiegelschrank, 2 Spiegeltüren, 2 Glaseinlegeböden, 202 mm tief, 1200 mm breit, 720 mm hoch
Mirrored bathroom cabinet, 2 mirrored doors, 2 glass shelves, 202 mm deep, 1200 mm wide, 720 mm high

2 x WWBSP-72

Abschlusswange für Spiegelschrank, 16 mm stark, 213 mm tief, 720 mm hoch
Upright at end of run for mirrored bathroom cabinet, 16 mm thick, 213 mm deep, 720 mm high

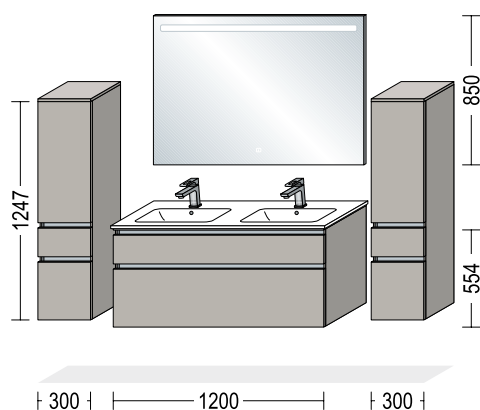

NBSET120-004

1 x NBMSA 30-125

Badezimmer-Midischrank, 1 Tür, 1 Schubkasten, 1 Auszug, 2 Einlegeböden, 320 mm tief, 300 mm breit, 1247 mm hoch
Bathroom Midi unit, 1 door, 1 drawer, 1 pull-out, 2 shelves, 320 mm deep, 300 mm wide, 1247 mm high

1 x ADB16-35

Abdeckboden, 16 mm stark, 343 mm tief, 303 mm breit
Top shelf, 16 mm thick, 343 mm deep, 303 mm wide

1 x NBWA 120-55

Badezimmer-Waschtischschrank, 1 feste Blende, 1 Auszug, 461 mm tief, 1200 mm breit, 554 mm hoch
Bathroom vanity unit, 1 fixed panel, 1 pull-out, 461 mm deep, 1200 mm wide, 554 mm high

1 x 87722

Doppelwaschtisch MEGX 1200D, 492 mm tief, 1214 mm breit, 142 mm hoch
Double hand basin MEGX 1200D, 492 mm deep, 1214 mm wide, 142 mm high

1 x SPLH 120

Spiegel mit horizontalem LED-Lichtfenster, 24 mm tief, 1200 mm breit, 850 mm hoch
Mirror with horizontal LED light window, 24 mm deep, 1200 mm wide, 850 mm high

1 x NBMSA 30-125

Badezimmer-Midischrank, 1 Tür, 1 Schubkasten, 1 Auszug, 2 Einlegeböden, 320 mm tief, 300 mm breit, 1247 mm hoch
Bathroom Midi unit, 1 door, 1 drawer, 1 pull-out, 2 shelves, 320 mm deep, 300 mm wide, 1247 mm high

1 x ADB16-35

Abdeckboden, 16 mm stark, 343 mm tief, 303 mm breit
Top shelf, 16 mm thick, 343 mm deep, 303 mm wide

Die Planungsvorschläge enthalten keine Armaturen, Leuchten oder Steckdosen. Diese müssen zusätzlich zur Set-Artikelnummer bestellt werden.

The planning suggestions do not include taps, lights or sockets. These must be ordered in addition to the set item number.

Waschtischgröße Hand basin size

1500 mm

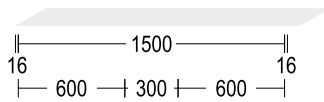
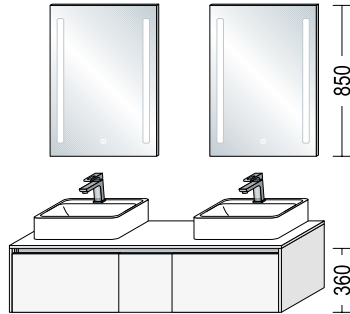

NBSET150-001

1 x NBWA 60-36

Badezimmer-Waschtischschrank, 1 Auszug, 461 mm tief, 600 mm breit, 360 mm hoch
Bathroom vanity unit, 1 pull-out, 461 mm deep, 600 mm wide, 360 mm high

1 x NBUA 30-36

Badezimmer-Auszugschrank, 1 Auszug, 461 mm tief, 300 mm breit, 360 mm hoch
Bathroom pull-out unit, 1 pull-out, 461 mm deep, 300 mm wide, 360 mm high

1 x NBWA 60-36

Badezimmer-Waschtischschrank, 1 Auszug, 461 mm tief, 600 mm breit, 360 mm hoch
Bathroom vanity unit, 1 pull-out, 461 mm deep, 600 mm wide, 360 mm high

1 x ADB16-59

Abdeckboden, 16 mm stark, 484 mm tief, 1535 mm breit
Top shelf, 16 mm thick, 484 mm deep, 1535 mm wide

2 x 87725

Aufsatzwaschtisch WB 0002 W 520C, 450 mm tief, 519 mm breit, 162 mm hoch
Surface-mounted hand basin WB 0002 W 520C, 450 mm deep, 519 mm wide, 162 mm high

2 x NBWU16-36

Abschlusswangen, 16 mm stark, 482 mm tief, 360 mm hoch
End uprights, 16 mm thick, 482 mm deep, 360 mm high

2 x SPLV 60

Spiegel mit vertikalen LED-Lichtfenstern, 24 mm tief, 600 mm breit, 850 mm hoch
Mirror with vertical LED light windows, 24 mm deep, 600 mm wide, 850 mm high

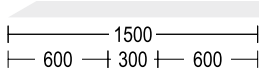
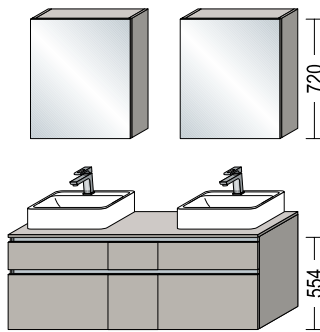

NBSET150-002

1 x NBWSA 60-55

Badezimmer-Waschtischschrank, 1 Schubkasten, 1 Auszug, 461 mm tief, 600 mm breit, 554 mm hoch
Bathroom vanity unit, 1 drawer, 1 pull-out, 461 mm deep, 600 mm wide, 554 mm high

1 x NBUSA 30-55

Badezimmer-Auszugschrank, 1 Schubkasten, 1 Auszug, 461 mm tief, 300 mm breit, 554 mm hoch
Bathroom pull-out unit, 1 drawer, 1 pull-out, 461 mm deep, 300 mm wide, 554 mm high

1 x NBWSA 60-55

Badezimmer-Waschtischschrank, 1 Schubkasten, 1 Auszug, 461 mm tief, 600 mm breit, 554 mm hoch
Bathroom vanity unit, 1 drawer, 1 pull-out, 461 mm deep, 600 mm wide, 554 mm high

2 x 87726

Aufsatzwaschtisch WB 0517 C 600C, 470 mm tief, 600 mm breit, 144 mm hoch
Surface-mounted hand basin WB 0517 C 600C, 470 mm deep, 600 mm wide, 144 mm high

1 x ADB16-59

Abdeckboden, 16 mm stark, 484 mm tief, 1503 mm breit
Top shelf, 16 mm thick, 484 mm deep, 1503 mm wide

2 x WBSP 60-02

Spiegelschrank, 1 Spiegeltür, 2 Glaseinlegeböden, 202 mm tief, 600 mm breit, 720 mm hoch
Mirrored bathroom cabinet, 1 mirrored door, 2 glass shelves, 202 mm deep, 600 mm wide, 720 mm high

Die Planungsvorschläge enthalten keine Armaturen, Leuchten oder Steckdosen. Diese müssen zusätzlich zur Set-Artikelnummer bestellt werden.

The planning suggestions do not include taps, lights or sockets. These must be ordered in addition to the set item number.

DETAILS INNENAUSSTATTUNG UND ZUBEHÖR*

DETAILS OF INTERIOR FITTINGS AND ACCESSORIES*



Spiegelschrank mit Doppelsteckdose

Mirrored cabinet with double socket



Einbau-Abfallsammler Seperato

Built-in waste collector Seperato



Siphon-Aussparung

Siphon cut-out



3-teiliges Utensilien-System zur Abdeckung der Siphon-Aussparung

3-part utensil system to cover the siphon cut-out



Handtuchhalter zur Planung auf 16 mm starken Wangen

Towel rail for planning on 16 mm thick upright panels



Wandkonsole aus Stahl, lieferbar in Schwarz und Chrom Glanz

Wall bracket in steel, available in black and chrome gloss

*Unser umfangreiches Sortiment an Innenausstattung und Zubehör entnehmen Sie bitte unserem Verkaufshandbuch.

*Please refer to our sales manual for our extensive range of interior fittings and accessories.

FRONTEN FRONTS



SPEED 244 PG 1
Alpinweiß

SPEED 244 PG 1
Alpine white



SPEED 239 PG 1
Weiß softmatt

SPEED 239 PG 1
White softmatt



SPEED 206 PG 1
Magnolia softmatt

SPEED 206 PG 1
Ivory softmatt



SPEED 259 PG 1
Seidengrau

SPEED 259 PG 1
Satin grey



SPEED 288 PG 1
Schwarzbeton Nachbildung

SPEED 288 PG 1
Black Concrete reproduction



SPEED 262 PG 1
Eiche Virginia Nachbildung

SPEED 262 PG 1
Virginia oak reproduction



LASER 427 PG 2
Alpinweiß

LASER 427 PG 2
Alpine white



LASER 416 PG 2
Weiß

LASER 416 PG 2
White

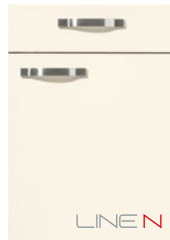

LASER 418 PG 2
Magnolia matt

LASER 418 PG 2
Ivory matt



LASER 417 PG 2
Seidengrau

LASER 417 PG 2
Satin grey



LASER 415 PG 2
Sand

LASER 415 PG 2
Sand

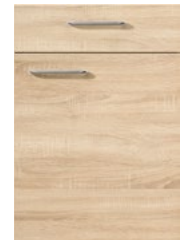

RIO 666 PG 2
Eiche Virginia Nachbildung

RIO 666 PG 2
Virginia oak reproduction

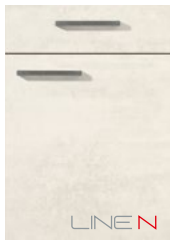

RIVA 891 PG 2
Weißbeton Nachbildung

RIVA 891 PG 2
White Concrete reproduction

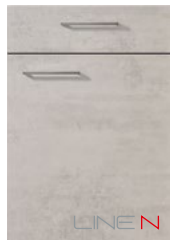

RIVA 892 PG 2
Beton grau Nachbildung

RIVA 892 PG 2
Concrete grey reproduction



RIVA 889 PG 2
Beton schiefergrau Nachbildung

RIVA 889 PG 2
Concrete Slate Grey reproduction



RIVA 893 PG 2
Eiche San Remo Nachbildung

RIVA 893 PG 2
Sanremo oak reproduction



RIVA 887 PG 2
Eiche Somerset Nachbildung

RIVA 887 PG 2
Somerset oak reproduction



STRUCTURA 401 PG 3
Eiche Halifax Nachbildung

STRUCTURA 401 PG 3
Sherwood oak reproduction



STRUCTURA 402 PG 3
Eiche Havanna Nachbildung

STRUCTURA 402 PG 3
Havana oak reproduction



STRUCTURA 405 PG 3
Eiche Sierra Nachbildung

STRUCTURA 405 PG 3
Sierra oak reproduction



STRUCTURA 403 PG 3
Eiche Nero Nachbildung

STRUCTURA 403 PG 3
Nero oak reproduction



TOUCH 332 PG 3
Lacklaminat, Alpinweiß supermatt

TOUCH 332 PG 3
Lacquered laminate, alpine white supermatt



TOUCH 336 PG 3
Lacklaminat, Magnolia supermatt

TOUCH 336 PG 3
Lacquered laminate, ivory supermatt



TOUCH 338 PG 3
Lacklaminat, Seidengrau supermatt

TOUCH 338 PG 3
Lacquered laminate, satin grey supermatt

Fronten, die mit dem LINE N-Logo versehen sind, sind auch als grifflose Bäder lieferbar.
Fronts marked with the LINE N logo are also available as handleless bathrooms.

FRONTEN FRONTS



TOUCH 341 PG 3
Lacklaminat,
Steingrau supermatt

TOUCH 341 PG 3
Lacquered laminate,
stone grey supermatt



TOUCH 337 PG 3
Lacklaminat,
Aqua supermatt

TOUCH 337 PG 3
Lacquered laminate,
aqua supermatt



TOUCH 334 PG 3
Lacklaminat,
Schiefergrau supermatt

TOUCH 334 PG 3
Lacquered laminate,
slate grey supermatt

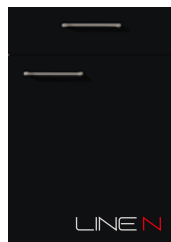

TOUCH 340 PG 3
Lacklaminat,
Schwarz supermatt

TOUCH 340 PG 3
Lacquered laminate,
black supermatt



FLASH 503 PG 3
Lacklaminat,
Alpinweiß Hochglanz

FLASH 503 PG 3
Lacquered laminate,
alpine white high gloss



FLASH 450 PG 3
Lacklaminat,
Weiß Hochglanz

FLASH 450 PG 3
Lacquered laminate,
white high gloss

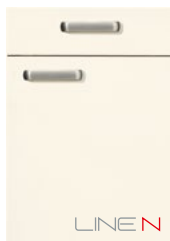

FLASH 452 PG 3
Lacklaminat,
Magnolia Hochglanz

FLASH 452 PG 3
Lacquered laminate,
ivory high gloss



FLASH 455 PG 3
Lacklaminat,
Seidengrau Hochglanz

FLASH 455 PG 3
Lacquered laminate,
satin grey high gloss



FLASH 453 PG 3
Lacklaminat,
Schiefergrau Hochglanz

FLASH 453 PG 3
Lacquered laminate,
slate grey high gloss



EASYTOUCH 961 PG 4
Lacklaminat,
Grafit schwarz ultramatt

EASYTOUCH 961 PG 4
Lacquered laminate,
graphite black ultra matt



EASYTOUCH 963 PG 4
Lacklaminat,
Rostrot ultramatt

EASYTOUCH 963 PG 4
Lacquered laminate,
rust red ultra matt



STONEART 304 PG 4
Lacklaminat,
Schiefer steingrau
Nachbildung

STONEART 304 PG 4
Stone grey slate
reproduction



STONEART 303 PG 4
Lacklaminat,
Grauschiefer
Nachbildung

STONEART 303 PG 4
Grey slate
reproduction



INOX 216 PG 4
Lacklaminat, Stahl
gebürstet Nachbildung

INOX 216 PG 4
Lacquered laminate,
brushed steel
reproduction



FASHION 168 PG 4
Lack,
Alpinweiß matt

FASHION 168 PG 4
Lacquer,
honed alpine white



FASHION 173 PG 4
Lack,
Weiß matt

FASHION 173 PG 4
Lacquer,
honed white



FASHION 175 PG 4
Lack,
Magnolia matt

FASHION 175 PG 4
Lacquer,
honed ivory



FASHION 171 PG 4
Lack,
Seidengrau matt

FASHION 171 PG 4
Lacquer,
honed satin grey



FASHION 165 PG 4
Lack,
Steingrau matt

FASHION 165 PG 4
Lacquer,
honed stone grey



FOCUS 470 PG 4
Lack, Alpinweiß
Ultra-Hochglanz

FOCUS 470 PG 4
Lacquer, alpine white
ultra high gloss



FOCUS 460 PG 4
Lack,
Weiß Ultra-Hochglanz

FOCUS 460 PG 4
Lacquer,
white ultra high gloss

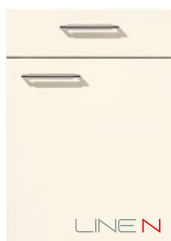

FOCUS 462 PG 4
Lack, Magnolia
Ultra-Hochglanz

FOCUS 462 PG 4
Lacquer,
ivory ultra high gloss

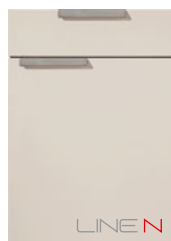

FOCUS 467 PG 4
Lack,
Sand Ultra-Hochglanz

FOCUS 467 PG 4
Lacquer,
sand ultra high gloss

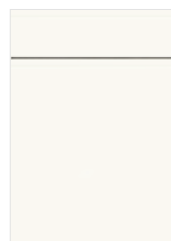

INLINE 551 PG 5
Lack,
Alpinweiß matt

INLINE 551 PG 5
Lacquer,
honed alpine white



GENT 741 PG 5
Lacklaminat, Steingrau

GENT 741 PG 5
Lacquered laminate, stone grey



CREDO 764 PG 6
Lacklaminat, Alpinweiß

CREDO 764 PG 6
Lacquered laminate, alpine white



CREDO 765 PG 6
Lacklaminat, Schiefergrau

CREDO 765 PG 6
Lacquered laminate, slate grey



KANSAS 597 PG 7
Eiche Sierra Nachbildung

KANSAS 597 PG 7
Sierra oak reproduction

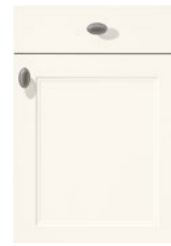

CASCADA 774 PG 7
Lacklaminat, Weiß

CASCADA 774 PG 7
Lacquered laminate, white



CASCADA 772 PG 7
Lacklaminat, Steingrau

CASCADA 772 PG 7
Lacquered laminate, stone grey



CASCADA 776 PG 7
Lacklaminat, Schilf

CASCADA 776 PG 7
Lacquered laminate, reed green



SYLT 847 PG 7
Lack, Alpinweiß matt

SYLT 847 PG 7
Lacquer, honed alpine white



SYLT 849 PG 7
Lack, Magnolia matt

SYLT 849 PG 7
Lacquer, honed ivory



SYLT 851 PG 7
Lack, Schwarz matt

SYLT 851 PG 7
Lacquer, honed black



CASTELLO 390 PG 8
Magnolia gewischt

CASTELLO 390 PG 8
Washed ivory

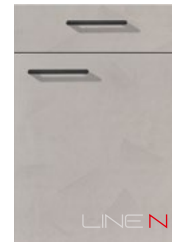

CEMENTO 803 PG 8
Lack, Zementgrau

CEMENTO 803 PG 8
Lacquer, cement grey



LUX 817 PG 9
Lack, Alpinweiß Hochglanz

LUX 817 PG 9
Lacquer, alpine white high gloss



LUX 814 PG 9
Lack, Weiß Hochglanz

LUX 814 PG 9
Lacquer, white high gloss



LUX 816 PG 9
Lack, Magnolia Hochglanz

LUX 816 PG 9
Lacquer, ivory high gloss



LUX 819 PG 9
Lack, Seidengrau Hochglanz

LUX 819 PG 9
Lacquer, satin grey high gloss



LUX 823 PG 9
Lack, Schiefergrau Hochglanz

LUX 823 PG 9
Lacquer, slate grey high gloss

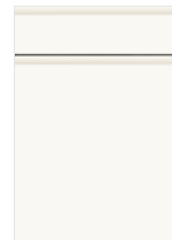

PURA 834 PG 9
Lack, Weiß Hochglanz

PURA 834 PG 9
Lacquer, white high gloss



CHALET 885 PG 9
Lack, Weiß matt

CHALET 885 PG 9
Lacquer, honed white

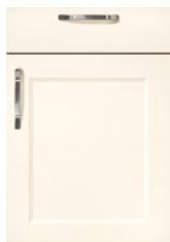

CHALET 883 PG 9
Lack, Magnolia matt

CHALET 883 PG 9
Lacquer, honed ivory



CHALET 881 PG 9
Lack, Sand matt

CHALET 881 PG 9
Lacquer, honed sand



YORK 905 PG 9
Echtholz, Magnolia lackiert

YORK 905 PG 9
Genuine wood, lacquered ivory



YORK 901 PG 9
Echtholz, Seidengrau lackiert

YORK 901 PG 9
Genuine wood, lacquered satin grey

ARBEITSPLATTEN WORKTOPS

70-71



066 Schiefer Nachbildung
066 Slate décor reproduction



070* Seidengrau
070* Satin grey



078 Eiche San Remo Nachbildung
078 Sanremo oak reproduction



089* Steingrau
089* Stone grey



097 Eiche Havanna Nachbildung
097 Havana oak reproduction



117 Copper Vintage Nachbildung
117 Vintage Copper décor



123 Eiche Virginia Nachbildung
123 Virginia oak reproduction



186 Schwarz
186 Black



192 Eiche Provence Nachbildung
192 Oak Provence reproduction



193* Alpinweiß
193* Alpine white



194* Schiefergrau
194* Slate grey



196 Eiche Ontario Nachbildung
196 Ontario oak reproduction



198 Eiche Sierra Nachbildung
198 Sierra oak reproduction

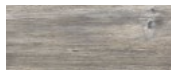

204 Ponderosa Pine Nachbildung
204 Ponderosa pine reproduction



215 Stromboli hell Nachbildung
215 Strombolian light reproduction



220 Arizona Pine Nachbildung
220 Arizona pine reproduction



225 Stammeiche Nachbildung
225 Stem oak reproduction



226 Dekor Metal Art
226 Metal art décor



265 Rusty Plates Nachbildung
265 Rusty plates reproduction



266 Caledonia
266 Caledonia



272 Balkeneiche Nachbildung
272 Timber oak reproduction



273 Carrara Nachbildung
273 Carrara marble reproduction



274 Marmor Teramo Nachbildung
274 Teramo marble reproduction



316 Maracaibo hell Nachbildung
316 Maracaibo light décor



319 Dekor Oxid
319 Oxid décor



330* Beton grau Nachbildung
330* Concrete grey reproduction



344* Granit schwarz geflammt Nachbildung
344* Black granite décor



345 Eiche Yukon Nachbildung
345 Yukon oak reproduction

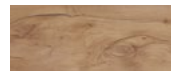

347 Taxus Nachbildung
347 Taxus reproduction



352 Eiche Halifax Nachbildung
352 Sherwood oak reproduction



353* Weißbeton Nachbildung
353* White Concrete reproduction



354* Beton schiefergrau Nachbildung
354* Concrete Slate Grey reproduction

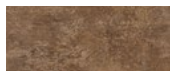

355* Ferro Bronze Nachbildung
355* Ferro bronze décor



356 Endgrain Oak Nachbildung
356 Endgrain oak reproduction



376* Limestone Nachbildung
376* Limestone reproduction



377 Eiche geölt Nachbildung
377 Oiled oak reproduction



378 Schwarzbeton Nachbildung
378 Black Concrete reproduction



379 Eiche Somerset Nachbildung
379 Somerset oak reproduction



393 Vintage Oak Nachbildung
393 Vintage oak reproduction



394 Travertin sandbeige Nachbildung
394 Champagne travertine reproduction



395 Verso Nachbildung
395 Verso reproduction



396 Terrazzo grau Nachbildung
396 Grey terrazzo reproduction



Arbeitsplatte APN mit N-Kante
Worktop APN with N edge



Arbeitsplatte APD mit Dekorkante
Worktop APD with décor edge

XTRA



367* Eiche Artisan Nachbildung
367* Artisan oak reproduction

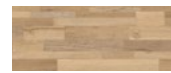

368 Mixwood Nachbildung
368 Mixedwood reproduction



369* Schiefer steingrau Nachbildung
369* Stone grey slate reproduction



373* Grauschiefer Nachbildung
373* Grey slate reproduction



Eine Ansicht der kompletten Dekorlänge finden Sie auf www.nobilite.de
A view of the entire length of the décor can be found at www.nobilite.de

* Auch als Slim Line-Arbeitsplatte, 16 mm stark, lieferbar.
* Also available as Slim Line worktop, 16 mm thick.

KORPUSDEKORE CARCASE DÉCORS



193 Alpinweiß

193 Alpine white



060 Alpinweiß Glanz

060 Alpine white gloss



106 Weiß

106 White



022 Weiß Glanz

022 White gloss



120 Magnolia matt

120 Ivory matt

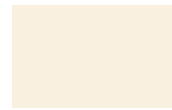

116 Magnolia Glanz

116 Ivory gloss

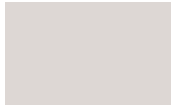

070 Seidengrau

070 Satin grey



089 Steingrau

089 Stone grey



122 Sand

122 Sand



194 Schiefergrau

194 Slate grey



**123 Eiche Virginia
Nachbildung**

123 Virginia oak
reproduction



**078 Eiche San Remo
Nachbildung**

078 Sanremo oak
reproduction



**198 Eiche Sierra
Nachbildung**

198 Sierra oak
reproduction



**097 Eiche Havanna
Nachbildung**

097 Havana oak
reproduction

COLOR CONCEPT COLOR CONCEPT



241 Sonnengelb

241 Maize Yellow



248 Farn

248 Fern



254 Aqua

254 Aqua



257 Salbei

257 Sage



**265 Rusty Plates
Nachbildung**

265 Rusty plates
reproduction



266 Caledonia

266 Caledonia

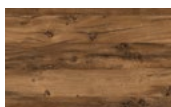

**272 Balkeneiche
Nachbildung**

272 Timber oak
reproduction



**273 Carrara
Nachbildung**

273 Carrara marble
reproduction



**274 Marmor Teramo
Nachbildung**

274 Teramo marble
reproduction



**355 Ferro Bronze
Nachbildung**

355 Ferro bronze
décor

GRIFFAUSWAHL[™] HANDLE SELECTION[™]

Griffe edelstahlfarbig Handles in stainless steel finish

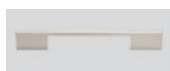

**013* Metallgriff
Edelstahlfarbig**

013* Metal handle
Stainless steel finish



**019* Metallgriff
Edelstahlfarbig**

019* Metal handle
Stainless steel finish

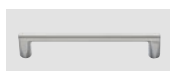

**042 Metallgriff
Edelstahlfarbig**

042 Metal handle
Stainless steel finish



**062 Metallgriff
Edelstahlfarbig**

062 Metal handle
Stainless steel finish



**067 Metallgriff
Edelstahlfarbig**

067 Metal handle
Stainless steel finish



**069 Metallgriff
Edelstahlfarbig**

069 Metal handle
Stainless steel finish



**077 Metallgriff
Edelstahlfarbig**

077 Metal handle
Stainless steel finish



**098 Metallgriff
Nickel matt**

098 Metal handle
Matt nickel



**183 Metallgriff
Edelstahlfarbig**

183 Metal handle
Stainless steel finish



**186 Metallgriff
Edelstahlfarbig**

186 Metal handle
Stainless steel finish



**218 Metallgriff
Edelstahlfarbig/
Chrom Glanz**

218 Metal handle
Stainless steel finish/
Brilliant chrome



**221 Metallgriff
Edelstahlfarbig**

221 Metal handle
Stainless steel finish



**237 Metallgriff
Edelstahlfarbig**

237 Metal handle
Stainless steel finish



**263 Metallgriff
Edelstahlfarbig**

263 Metal handle
Stainless steel finish



**279 Metallgriff
Edelstahlfarbig**

279 Metal handle
Stainless steel finish



**331 Metallgriff
Edelstahlfarbig**

331 Metal handle
Stainless steel finish



**508 Metallgriff
Edelstahlfarbig**

508 Metal handle
Stainless steel finish



**544 Metallgriff
Edelstahlfarbig**

544 Metal handle
Stainless steel finish



**549 Metallgriff
Edelstahlfarbig**

549 Metal handle
Stainless steel finish



**552 Metallgriff
Edelstahlfarbig**

552 Metal handle
Stainless steel finish



**602 Metallgriff
Edelstahlfarbig**

602 Metal handle
Stainless steel finish



**608 Metallgriff
Edelstahlfarbig**

608 Metal handle
Stainless steel finish



**708 Metallgriff
Edelstahlfarbig**

708 Metal handle
Stainless steel finish



**801 Metallgriff
Edelstahlfarbig**

801 Metal handle
Stainless steel finish

Griffe Anthrazit/Schwarz Handles in Anthracite/Black



**563 Metallgriff
Schwarz/Edelstahl-
farbig**

563 Metal handle
Black/Stainless steel
finish



**570 Metallgriff
Schwarz**

570 Metal handle
Black



**595 Metallgriff
Schwarz/Edelstahl-
farbig**

595 Metal handle
Black/Stainless steel
finish



**616 Gusseisengriff
Schwarz**

616 Cast iron handle
Black



**707 Metallgriff
Anthrazit gebürstet**

707 Metal handle
Brushed anthracite

Knöpfe Knobs



**610 Gusseisenknopf
Schwarz**

610 Cast iron knob
Black



**677 Metallknopf
Edelstahlfarbig**

677 Metal knob
Stainless steel finish



**678 Metallknopf
Edelstahlfarbig**

678 Metal knob
Stainless steel finish



**679 Metallknopf
Schwarz**

679 Metal knob
Black

«Unser gesamtes Angebotsspektrum von Griffen entnehmen Sie bitte unserem Verkaufshandbuch.
«Please refer to our sales manual for our complete range of handles.

*Dieser Griff ist mehrpreispflichtig.
*This handle requires a surcharge.

Griffe mit Effektveredelung Handles with effect finishing



056 Metallgriff
Used look

056 Metal handle
Used look



088 Metallgriff
Anthrazit gebürstet

088 Metal handle
Brushed anthracite



099 Metallgriff
Industrial Style

099 Metal handle
Industrial Style



119 Metallgriff
Altsilberfarbig

119 Metal handle
Antique silver colour



190* Bügelgriff
Chrom Glanz

190* Bow handle
Brilliant chrome



192 Metallgriff
Chrom Glanz

192 Metal handle
Brilliant chrome



271 Metallgriff
Titanfarbig

271 Metal handle
Titanium-coloured



280 Metallgriff
Alteisenfarbig

280 Metal handle
Antique iron colour



284 Metallgriff
Altsilberfarbig

284 Metal handle
Antique silver colour



358 Metallgriff
Titanfarbig

358 Metal handle
Titanium-coloured



509 Metallgriff
Grau

509 Metal handle
grey



556 Metallgriff
Altsilberfarbig

556 Metal handle
Antique silver colour



733 Metallgriff
Schwarzchrom

733 Metal handle
Chromed black



737 Holz-Metallgriff
Eiche/Schwarz

737 Wood/Metal
handle Oak/Black



739* Metallgriff
Schwarz

739* Metal handle
black



799 Metallgriff
Schwarzchrom

799 Metal handle
Chromed black

Griffleisten Bar handles



240* Griffleiste
Schwarz

240* Bar handle
Black



300* Griffleiste
Edelstahlfarbig

300* Bar handle
Stainless steel finish

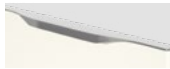

350* Griffleiste
Edelstahlfarbig

350* Bar handle
Stainless steel finish



430* Griffleiste
Edelstahlfarbig

430* Bar handle
Stainless steel finish



550* Griffleiste
Edelstahlfarbig

550* Bar handle
Stainless steel finish



600* Griffleiste
Schwarz

600* Bar handle
Black



690* Griffleiste
Alpinweiß

690* Bar handle
alpine white



710* Griffleiste
Steingrau

710* Bar handle
stone grey



730* Griffleiste
Schiefergrau

730* Bar handle
slate grey



760* Griffleiste
Edelstahlfarbig

760* Bar handle
Stainless steel finish



870* Griffleiste
Schwarz

870* Bar handle
Black

Relingstangen Railing handles



370* Relingstange
Edelstahlfarbig

370* Railing handle
Stainless steel finish



620* Relingstange
Schwarz

620* Railing handle
Black

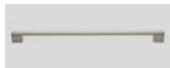

650* Relingstange
Edelstahlfarbig

650* Railing handle
Stainless steel finish



900* Relingstange
Edelstahlfarbig

900* Railing handle
Stainless steel finish



930* Relingstange
Edelstahlfarbig

930* Railing handle
Stainless steel finish

***Dieser Griff ist mehrpreispflichtig.**

*This handle requires a surcharge.

Technische Änderungen, Liefermöglichkeiten, Irrtümer und drucktechnisch bedingte Farbabweichungen vorbehalten. Alle Einrichtungsbeispiele sind unverbindlich. All rights to technical alterations, delivery possibilities, errors and printing-related colour deviations are reserved. All furnishing examples are non-binding.



Qualität made in Germany

Quality made in Germany

Ausgesuchte Materialien, exzellente Verarbeitung, Perfektion bis ins Detail: Unsere Bäder werden nach höchsten Qualitätskriterien entwickelt und gefertigt. Dabei produzieren wir ausschließlich am Standort Deutschland.

Bevor unsere Produkte in Serie gehen, werden alle eingesetzten Materialien in umfangreichen Testverfahren im Labor auf eine Mindestlebensdauer von 15 Jahren geprüft und durch internationale, unabhängige Institute kontrolliert und zertifiziert. Denn die Zufriedenheit unserer Kunden ist für uns der höchste Maßstab.

Selected materials, excellent workmanship, perfection right down to the finest detail: our bathrooms are developed and manufactured according to the highest quality criteria. Our products are made exclusively in Germany.

Before our products go into production, all the materials used are subjected to extensive test procedures in the laboratory for a minimum service life of 15 years and inspected and certified by independent international institutes. After all, our customers' satisfaction is our benchmark.







nobilia-Werke
J. Stickling GmbH & Co. KG
Waldstraße 53-57
33415 Verl
info@nobilia.de
www.nobilia.de

Bad Broschüre 2020

91447



DE/EN